

Forest

Robby Cantarutti & Partners



^{IT} In alluminio estruso e pressofuso, Forest é una seduta dal design aggraziato e iconico. Disponibili in molte varianti, le sedute Forest fondono natura e tecnologia e si collocano perfettamente sia in esterno che in interno; rispondono ai bisogni di uno stile minimal ma di carattere, tanto nel residenziale quanto nel contract.

^{EN} In extruded and die cast aluminium, Forest is characterised by an elegant and iconic design. Available in multiple colours, the seats of the collection Forest merge nature with technology and are the perfect fit both indoors and outdoors; they meet the needs for a minimal yet distinguished style, in both residential and contract settings.

Descrizione / Description

Misure / Quotes

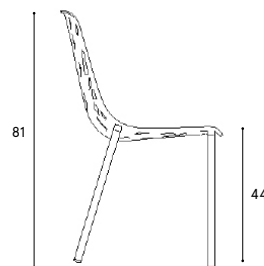
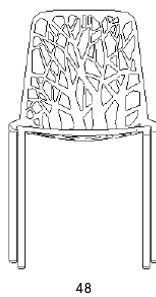

Caratteristiche / Characteristics

Sedia in alluminio verniciato / Chair in painted aluminium

Design / Design

Design Robby Cantarutti & Partners | 2008

Dimensioni / Dimensions

cm 48 x 53 x 44/81 h

Esterno / Outdoor

Sì / Yes

Struttura / Structure

Alluminio pressofuso ed estruso / Die-cast and extruded aluminium

Elementi plastici / Plastic elements

Polipropilene ed elastomero termoplastico / Polypropylene and thermoplastics elastomer

Finitura / Paint finishes

Verniciatura polveri poliesteri o poliuretaniche / Paint finish with polyester or polyurethane powders

Impilabilità / Stackability

Sì 8 pezzi / Yes 8 pieces

Viterie assemblaggio / Assembly screws

Acciaio inox / Stainless steel

Peso netto singolo pezzo / Net weight

4,6 kg

Pezzi per scatola / Units per package

4 assemblati / 4 assembled

Dimensione e volume imballo / Packaging dimension and volume

86 x 52 x 73 h cm 0.327 m³

Peso lordo imballo / Gross weight package

22,2 kg

Garanzia / Quality guarantee

2 anni / 2 years

Accessori / Accessories



609



614



632



623

Descrizione / Description

Misure / Quotes

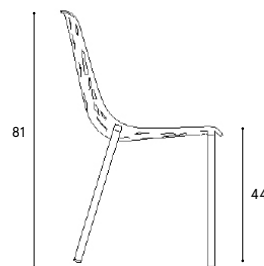
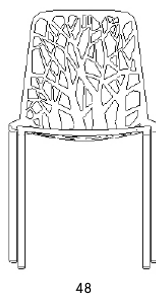

Caratteristiche / Characteristics

Sedia in alluminio verniciato con gambe rivestite in Iroko / Chair in painted aluminium with legs covered in Iroko

Design / Design

Design Robby Cantarutti & Partners | 2020

Dimensioni / Dimensions

cm 48 x 53 x 44/81 h

Esterno / Outdoor

Si / Yes

Struttura / Structure

Alluminio pressofuso ed estruso / Die-cast and extruded aluminium

Elementi plastici / Plastic elements

Polipropilene ed elastomero termoplastico / Polypropylene and thermoplastics elastomer

Finitura / Paint finishes

Verniciatura polveri poliesteri o poliuretaniche / Paint finish with polyester or polyurethane powders

Impilabilità / Stackability

Si 8 pezzi / Yes 8 pieces

Viterie assemblaggio / Assembly screws

Acciaio inox / Stainless steel

Peso netto singolo pezzo / Net weight

4,6 kg

Pezzi per scatola / Units per package

4 assemblati / 4 assembled

Dimensione e volume imballo / Packaging dimension and volume

86 x 52 x 73 h cm 0.327 m³

Peso lordo imballo / Gross weight package

22,2 kg

Garanzia / Quality guarantee

2 anni / 2 years

Accessori / Accessories



609



614



632



623

Descrizione / Description

Misure / Quotes

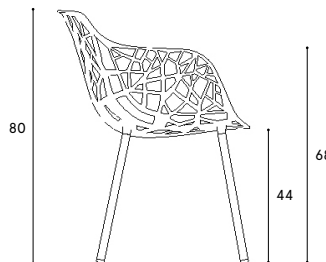

Caratteristiche / Characteristics

Poltroncina in alluminio verniciato / Dining armchair in painted aluminium

Design / Design

Design Robby Cantarutti & Partners | 2007

Dimensioni / Dimensions

cm 56 x 56 x 44/68/80 h

Esterno / Outdoor

Sì / Yes

Struttura / Structure

Alluminio pressofuso ed estruso / Die-cast and extruded aluminium

Elementi plastici / Plastic elements

Polipropilene ed elastomero termoplastico / Polypropylene and thermoplastics elastomer

Finitura / Paint finishes

Verniciatura polveri poliesteri o poliuretaniche/ Paint finish with polyester or polyurethane powders

Impilabilità / Stackability

No

Viterie assemblaggio / Assembly screws

Acciaio inox / Stainless steel

Peso netto singolo pezzo / Net weight

5,8 kg

Pezzi per scatola / Units per package

4 disassemblati / 4 disassembled

Dimensione e volume imballo / Packaging dimension and volume

60 x 67 x 63 h cm 0.253 m³

Peso lordo imballo / Gross weight package

27 kg

Garanzia / Quality guarantee

2 anni / 2 years

Accessori / Accessories



608



614



632



623

Descrizione / Description

Misure / Quotes

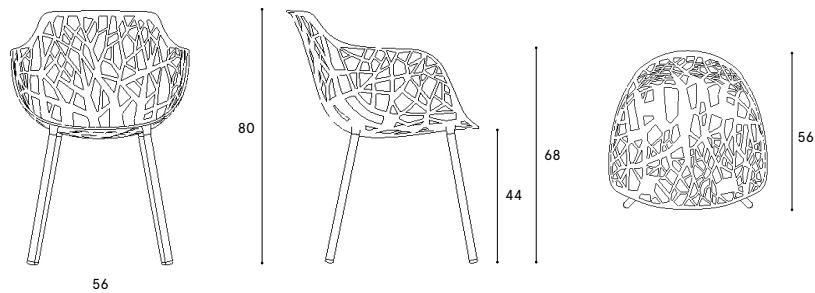

Caratteristiche / Characteristics

Poltroncina in alluminio verniciato con gambe rivestite in Iroko / Dining armchair in painted aluminium with legs covered in Iroko

Design / Design

Design Robby Cantarutti & Partners | 2020

Dimensioni / Dimensions

cm 56 x 56 x 44/68/80 h

Esterno / Outdoor

Si / Yes

Struttura / Structure

Alluminio pressofuso ed estruso / Die-cast and extruded aluminium

Elementi plastici / Plastic elements

Polipropilene ed elastomero termoplastico / Polypropylene and thermoplastics elastomer

Finitura / Paint finishes

Verniciatura polveri poliestere o poliuretaniche/ Paint finish with polyester or polyurethane powders

Impilabilità / Stackability

No

Viterie assemblaggio / Assembly screws

Acciaio inox / Stainless steel

Peso netto singolo pezzo / Net weight

5,8 kg

Pezzi per scatola / Units per package

4 disassemblati / 4 disassembled

Dimensione e volume imballo / Packaging dimension and volume

60 x 67 x 63 h cm 0.253 m³

Peso lordo imballo / Gross weight package

27 kg

Garanzia / Quality guarantee

2 anni / 2 years

Accessori / Accessories



608



614



632



623

Descrizione / Description

Misure / Quotes

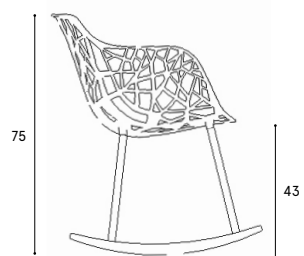
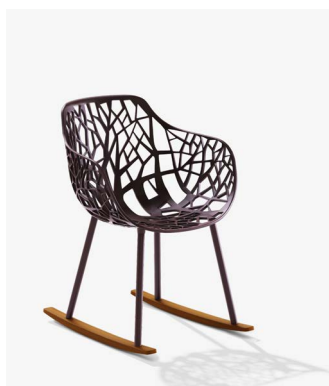

Caratteristiche / Characteristics

Poltroncina a dondolo in alluminio verniciato e slitte in iroko / Rocking armchair in painted aluminium and Iroko sleds

Design / Design

Design Robby Cantarutti & Partners | 2020

Dimensioni / Dimensions

cm 56 x 67 x 43/76 h

Esterno / Outdoor

Si / Yes

Struttura / Structure

Alluminio pressofuso ed estruso / Die-cast and extruded aluminium

Elementi plastici / Plastic elements

Polipropilene ed elastomero termoplastico / Polypropylene and thermoplastics elastomer

Finitura / Paint finishes

Verniciatura polveri poliesteri o poliuretaniche / Paint finish with polyester or polyurethane powders

Impilabilità / Stackability

No

Viterie assemblaggio / Assembly screws

Acciaio inox / Stainless steel

Peso netto singolo pezzo / Net weight

6,8 kg

Pezzi per scatola / Units per package

1 assemblato / 1 assembled

Dimensione e volume imballo / Packaging dimension and volume

cm 73 x 69 x 96 0,483 m³

Peso lordo imballo / Gross weight package

14 kg

Garanzia / Quality guarantee

2 anni / 2 years

Accessori / Accessories



608



614



632



623

Descrizione / Description

Misure / Quotes

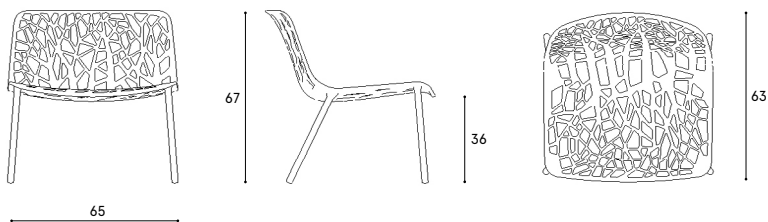

Caratteristiche / Characteristics

Poltrona lounge in alluminio verniciato / Lounge armchair in painted aluminium

Design / Design

Design Robby Cantarutti & Partners | 2018

Dimensioni / Dimensions

cm 65 x 65 x 67/36 h

Esterno / Outdoor

Sì / Yes

Struttura / Structure

Alluminio pressofuso ed estruso / Die-cast and extruded aluminium

Elementi plastici / Plastic elements

Polipropilene ed elastomero termoplastico / Polypropylene and thermoplastics elastomer

Finitura / Paint finishes

Verniciatura polveri poliestere o poliuretaniche / Paint finish with polyester or polyurethane powders

Impilabilità / Stackability

No

Viterie assemblaggio / Assembly screws

Acciaio inox / Stainless steel

Peso netto singolo pezzo / Net weight

7,8 kg

Pezzi per scatola / Units per package

1 assemblato / 1 assembled

Dimensione e volume imballo / Packaging dimension and volume

100 x 86 x 80 h cm 0.688 m³

Peso lordo imballo / Gross weight package

17 kg

Garanzia / Quality guarantee

2 anni / 2 years

Accessori / Accessories



630



631



633

Descrizione / Description

Misure / Quotes

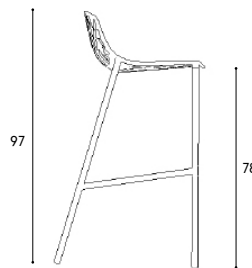
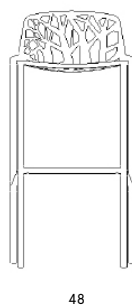

Caratteristiche / Characteristics

Sgabello in alluminio verniciato con poggiapiedi in acciaio inox lucidato / Stool in painted aluminium with footrest in polished stainless steel

Design / Design

Design Robby Cantarutti & Partners | 2008

Dimensioni / Dimensions

cm 48 x 56 x 78/79 h

Esterno / Outdoor

Si / Yes

Struttura / Structure

Alluminio pressofuso, estruso e acciaio inox / Die-cast, extruded aluminium and stainless steel

Elementi plastici / Plastic elements

Polipropilene ed elastomero termoplastico / Polypropylene and thermoplastics elastomer

Finitura / Paint finishes

Verniciatura polveri poliestere o poliuretaniche / Paint finish with polyester or polyurethane powders

Impilabilità / Stackability

No

Viterie assemblaggio / Assembly screws

Acciaio inox / Stainless steel

Peso netto singolo pezzo / Net weight

4,8 kg

Pezzi per scatola / Units per package

1 assemblato / 1 assembled

Dimensione e volume imballo / Packaging dimension and volume

52 x 73 x 97 h cm 0.354 m³

Peso lordo imballo / Gross weight package

11,2 kg

Garanzia / Quality guarantee

2 anni / 2 years

Accessori / Accessories



614



632



623

Descrizione / Description

Misure / Quotes

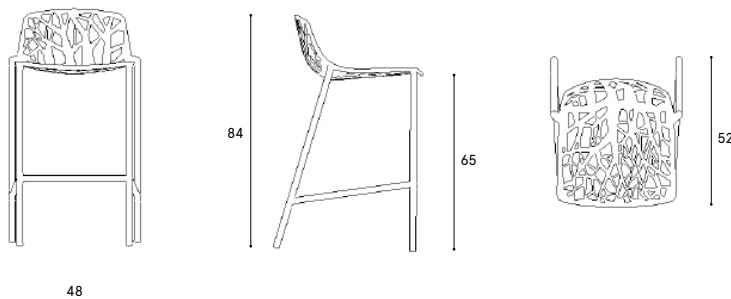

Caratteristiche / Characteristics

Sgabello in alluminio verniciato con poggipiedi in acciaio inox lucidato / Stool in painted aluminium with footrest in polished stainless steel

Design / Design

Design Robby Cantarutti & Partners | 2010

Dimensioni / Dimensions

cm 48 x 52 x 65/84 h

Esterno / Outdoor

Si / Yes

Struttura / Structure

Alluminio pressofuso, estruso e acciaio inox / Die-cast, extruded aluminium and stainless steel

Elementi plastici / Plastic elements

Polipropilene ed elastomero termoplastico / Polypropylene and thermoplastics elastomer

Finitura / Paint finishes

Verniciatura polveri poliestere o poliuretaniche / Paint finish with polyester or polyurethane powders

Impilabilità / Stackability

No

Viterie assemblaggio / Assembly screws

Acciaio inox / Stainless steel

Peso netto singolo pezzo / Net weight

4,3 kg

Pezzi per scatola / Units per package

1 assemblato / 1 assembled

Dimensione e volume imballo / Packaging dimension and volume

52 x 73 x 86 h cm 0.314 m³

Peso lordo imballo / Gross weight package

10,9 kg

Garanzia / Quality guarantee

2 anni / 2 years

Accessori / Accessories



614



632



623

Descrizione / Description

Misure / Quotes

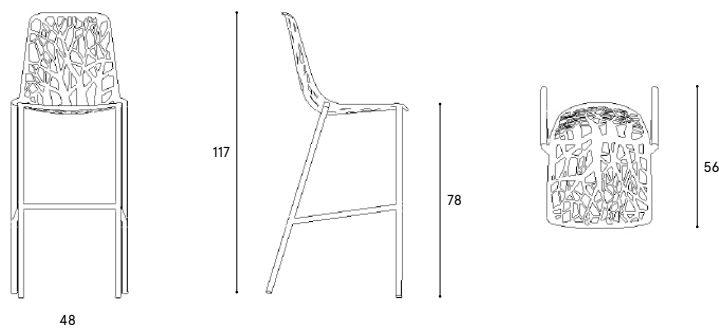

Caratteristiche / Characteristics

Sgabello con schienale alto in alluminio verniciato con poggiatesta in acciaio inox lucidato / Stool with high backrest in painted aluminium with footrest in polished stainless steel

Design / Design

Design Robby Cantarutti & Partners | 2011

Dimensioni / Dimensions

cm 48 x 56 x 78/117 h

Esterno / Outdoor

Si / Yes

Struttura / Structure

Alluminio pressofuso, estruso e acciaio inox / Die-cast, extruded aluminium and stainless steel

Elementi plastici / Plastic elements

Polipropilene ed elastomero termoplastico / Polypropylene and thermoplastics elastomer

Finitura / Paint finishes

Verniciatura polveri poliesteri o poliuretaniche / Paint finish with polyester or polyurethane powders

Impilabilità / Stackability

No

Viterie assemblaggio / Assembly screws

Acciaio inox / Stainless steel

Peso netto singolo pezzo / Net weight

5 kg

Pezzi per scatola / Units per package

1 assemblato / 1 assembled

Dimensione e volume imballo / Packaging dimension and volume

52x 62 x 120 h cm 0.372 m³

Peso lordo imballo / Gross weight package

11,5 kg

Garanzia / Quality guarantee

2 anni / 2 years

Accessori / Accessories



Descrizione / Description

Misure / Quotes

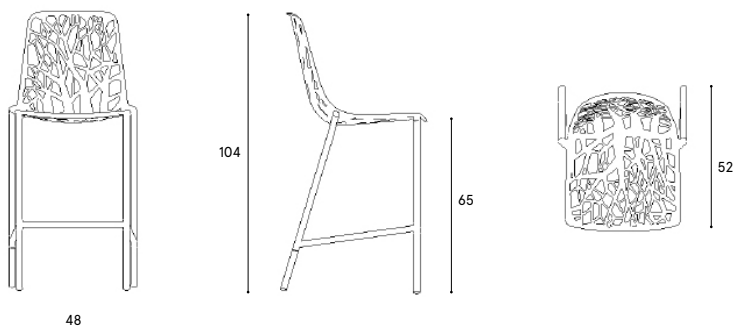

Caratteristiche / Characteristics

Sgabello con schienale alto in alluminio verniciato con poggiatesta in acciaio inox lucidato / Stool with high backrest in painted aluminium with footrest in polished stainless steel

Design / Design

Design Robby Cantarutti & Partners | 2011

Dimensioni / Dimensions

cm 48 x 52 x 65/104 h

Esterno / Outdoor

Si / Yes

Struttura / Structure

Alluminio pressofuso, estruso e acciaio inox / Die-cast, extruded aluminium and stainless steel

Elementi plastici / Plastic elements

Polipropilene ed elastomero termoplastico / Polypropylene and thermoplastics elastomer

Finitura / Paint finishes

Verniciatura polveri poliestere o poliuretaniche/ Paint finish with polyester or polyurethane powders

Impilabilità / Stackability

No

Viterie assemblaggio / Assembly screws

Acciaio inox / Stainless steel

Peso netto singolo pezzo / Net weight

4,7 kg

Pezzi per scatola / Units per package

1 assemblato / 1 assembled

Dimensione e volume imballo / Packaging dimension and volume

52 x 62 x 104 h cm 0.323 m³

Peso lordo imballo / Gross weight package

11,3 kg

Garanzia / Quality guarantee

2 anni / 2 years

Accessori / Accessories



609



614



632



623

Manutenzione / Maintenance

Alluminio verniciato: Le operazioni di ordinaria pulizia per l'alluminio verniciato vanno eseguite con acqua tiepida e detergente neutro, utilizzando un panno morbido, evitando l'utilizzo di prodotti abrasivi, aggressivi, a base acida o alcalina.

Iroko e rivestimento in Iroko: Per una buona conservazione nel tempo ed evitare l'ossidazione superficiale è consigliato oliare periodicamente i manufatti.

Per la manutenzione, avvalersi dell'apposito kit KTEAK01.

Ripulire le superfici con un panno morbido leggermente inumidito, lasciare asciugare e procedere all'applicazione di un velo d'olio.

Aluminium: Perform routine cleaning on painted aluminium with warm water and neutral detergent, using a soft cloth. Do not use aggressive, abrasive, acid- or alkalibased products.

Iroko and iroko coating: To prolong the life of your products and avoid surface oxidation, we recommend you to oil them on a regular basis.

Perform maintenance using the dedicated KTEAK01 kit.

Wipe the surfaces with a slightly damp, soft cloth, leave to dry and apply a thin film of oil.