

ZEBRA

Design Studio Lievore Altherr



^{IT} Realizzata in alluminio pressofuso, la collezione Zebra unisce la solidità del materiale alla leggerezza delle forme e, per questo, si adatta facilmente agli ambienti outdoor residenziali o contract. Nelle sedute, le linee gestuali dello schienale ricreano quell'effetto organico e irregolare caratteristico delle venature del legno e della pietra.

^{EN} Made in die cast aluminium, the collection Zebra combines the solidity of the material with the light weight of the shapes, hence, adapts easily to any outdoor setting, be it residential or contract. The gestural backrest pattern evokes the organic feel of wood grain or a mineral veins - perfectly irregular, perfectly natural.

FAST

Descrizione / Description

Misure / Quotes

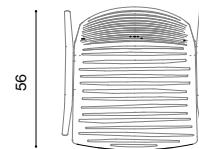
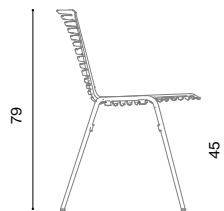
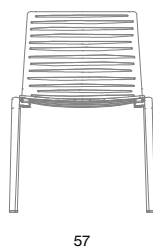

Caratteristiche / Characteristics

Sedia in alluminio verniciato / Chair in painted aluminium

Design / Design	Lievore Altherr 2016
Dimensioni / Dimensions	cm 57 x 56 x 45 / 79
Esterno / Outdoor	Si / yes
Struttura / Structure	Alluminio pressofuso / Die-cast aluminium
Elementi plastici / Plastic elements	Elastomero termoplastico e polipropilene / Thermoplastic elastomer and polypropylene
Finitura / Paint finishes	Verniciatura polveri poliesteri o poliuretaniche/ Paint finish with polyester or polyurethane powders
Impilabilità / Stackability	Si (6 pezzi) / yes (6 pieces)
Viterie assemblaggio / Assembly screws	Acciaio inox con trattamento antisvitamento / Stainless steel with anti-unscrewing treatment
Peso netto singolo pezzo / Net weight	6.5 kg
Pezzi per scatola / Units per package	2 assemblati / 2 assembled
Dimensione e volume imballo / Packaging dimension and volume	cm 73 x 69 x 96 h - 0,483 m ³
Peso lordo imballo / Gross weight package	21 kg
Garanzia / Quality guarantee	2 anni / 2 years
Accessori / Accessories	



624



625

Descrizione / Description

Misure / Quotes

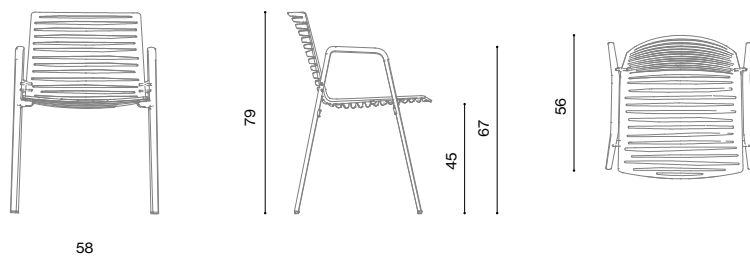

Caratteristiche / Characteristics

Sedia con braccioli in alluminio verniciato / Chair with armrests in painted aluminum

Design / Design	Lievore Altherr 2016
Dimensioni / Dimensions	cm 58 x 56 x 45 /67/ 79 h
Esterno / Outdoor	Si / yes
Struttura / Structure	Alluminio pressofuso / Die-cast aluminium
Elementi plastici / Plastic elements	Elastomero termoplastico e polipropilene / Thermoplastic elastomer and polypropylene
Finitura / Paint finishes	Verniciatura polveri poliesteri o poliuretaniche/ Paint finish with polyester or polyurethane powders
Impilabilità / Stackability	Si (6 pezzi) / yes (6 pieces)
Viterie assemblaggio / Assembly screws	Acciaio inox con trattamento antisvitamento / Stainless steel with anti-unscrewing treatment
Peso netto singolo pezzo / Net weight	7.2 kg
Pezzi per scatola / Units per package	2 assemblati / 2 assembled
Dimensione e volume imballo / Packaging dimension and volume	cm 73 x 69 x 96 h - 0,483 m ³
Peso lordo imballo / Gross weight package	22 kg
Garanzia / Quality guarantee	2 anni / 2 years
Accessori / Accessories	



626



627

Descrizione / Description

Misure / Quotes

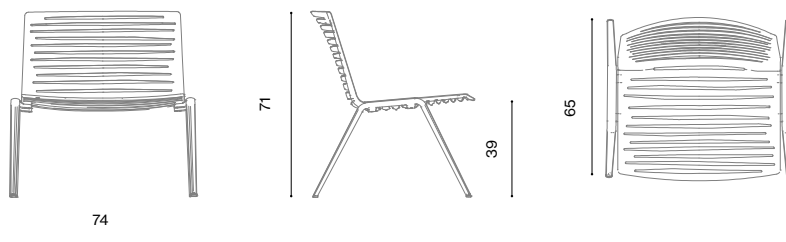

Caratteristiche / Characteristics

Poltrona lounge in alluminio verniciato / Lounge armchair in painted aluminium

Design / Design	Lievore Altherr 2018
Dimensioni / Dimensions	cm 74 x 65 x 39/71 h
Esterno / Outdoor	Si / yes
Struttura / Structure	Alluminio pressofuso / Die-cast aluminium
Elementi plastici / Plastic elements	Elastomero termoplastico e polipropilene / Thermoplastic elastomer and polypropylene
Finitura / Paint finishes	Verniciatura polveri poliesteri o poliuretaniche/ Paint finish with polyester or polyurethane powders
Impilabilità / Stackability	No
Viterie assemblaggio / Assembly screws	Acciaio inox / Stainless steel
Peso netto singolo pezzo / Net weight	10,22 kg
Pezzi per scatola / Units per package	1 assemblato / 1 assembled
Dimensione e volume imballo / Packaging dimension and volume	100 x 86 x 80 cm - 0.688 m ³
Peso lordo imballo / Gross weight package	20 kg
Garanzia / Quality guarantee	2 anni / 2 years
Accessori / Accessories	



628

Descrizione / Description

Misure / Quotes



Caratteristiche / Characteristics

Poggiapiedi in alluminio verniciato /Footrest in painted aluminium

Design / Design

Lievore Altherr | 2018

Dimensioni / Dimensions

cm 67 x 62 x 36/39 h

Esterno / Outdoor

Sì / yes

Struttura / Structure

Alluminio pressofuso e laminato / Die-cast and laminated aluminium

Elementi plastici / Plastic elements

Elastomero termoplastico e polipropilene / Thermoplastic elastomer and polypropylene

Finitura / Paint finishes

Verniciatura polveri poliesteri o poliuretaniche/ Paint finish with polyester or polyurethane powders

Impilabilità / Stackability

No

Viterie assemblaggio / Assembly screws

Acciaio inox / Stainless steel

Peso netto singolo pezzo / Net weight

8 kg

Pezzi per scatola / Units per package

1 assemblato / 1 assembled

Dimensione e volume imballo / Packaging dimension and volume

73 x 52 x 97 cm - 0.368 m³

Peso lordo imballo / Gross weight package

12 kg

Garanzia / Quality guarantee

2 anni / 2 years

Accessori / Accessories



628

Descrizione / Description

Misure / Quotes

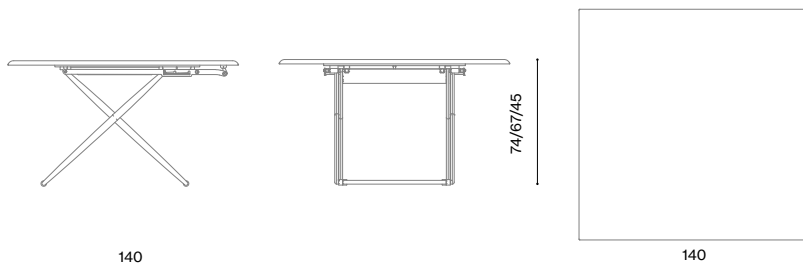

Caratteristiche / Characteristics

Tavolo Up&Down quadrato in alluminio verniciato regolabile in 3 altezze / Square Up&Down table with three adjustable heights in painted aluminium. Base on wheels

Design / Design	Lievore Altherr 2016
Dimensioni / Dimensions	cm 140 x 140 x 45/64/74 h
Esterno / Outdoor	Si / yes
Struttura / Structure	Alluminio pressofuso, estruso e laminato / Die-cast, extruded aluminium and laminated
Elementi plastici / Plastic elements	Elastomero termoplastico, polipropilene, policarbonato e resine acetaliche / Thermoplastic elastomer, polypropylene, polycarbonate and acetal resins
Finitura / Paint finishes	Verniciatura polveri poliesteri o poliuretaniche/ Paint finish with polyester or polyurethane powders
Impilabilità / Stackability	No
Elementi di movimento e posizionamento	Acciaio inox/ Stainless steel
Viterie assemblaggio / Assembly screws	Acciaio inox / Stainless steel
Peso netto singolo pezzo / Net weight	53,2 kg
Pezzi per scatola / Units per package	1 assemblato / 1 assembled
Dimensione e volume imballo / Packaging dimension and volume	cm 153 x 153 x 55 h - 1,287 m ³
Peso lordo imballo / Gross weight package	59 kg
Garanzia / Quality guarantee	2 anni / 2 years

Descrizione / Description

Misure / Quotes

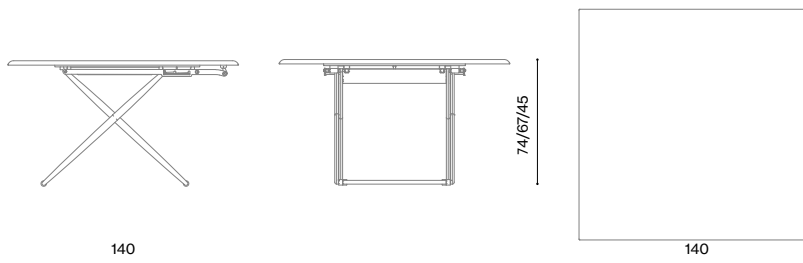

Caratteristiche / Characteristics

Tavolo Up&Down quadrato in alluminio verniciato regolabile in 3 altezze con piano in alluminio puntinato. Base su ruote. / Square Up&Down table with three adjustable heights in speckled aluminium. Base on wheels.

Design / Design	Lievore Altherr 2016
Dimensioni / Dimensions	cm 140 x 140 x 45/64/74 h
Esterno / Outdoor	Si / yes
Struttura / Structure	Alluminio pressofuso, estruso e laminato / Die-cast, extruded aluminium and laminated
Elementi plastici / Plastic elements	Elastomero termoplastico, polipropilene, policarbonato e resine acetaliche / Thermoplastic elastomer, polypropylene, polycarbonate and acetal resins
Finitura / Paint finishes	Verniciatura polveri poliesteri o poliuretaniche/ Paint finish with polyester or polyurethane powders
Impilabilità / Stackability	No
Elementi di movimento e posizionamento	Acciaio inox/ Stainless steel
Viterie assemblaggio / Assembly screws	Acciaio inox / Stainless steel
Peso netto singolo pezzo / Net weight	53,2 kg
Pezzi per scatola / Units per package	1 assemblato / 1 assembled
Dimensione e volume imballo / Packaging dimension and volume	cm 153 x 153 x 55 h - 1,287 m ³
Peso lordo imballo / Gross weight package	59 kg
Garanzia / Quality guarantee	2 anni / 2 years

Descrizione / Description

Misure / Quotes

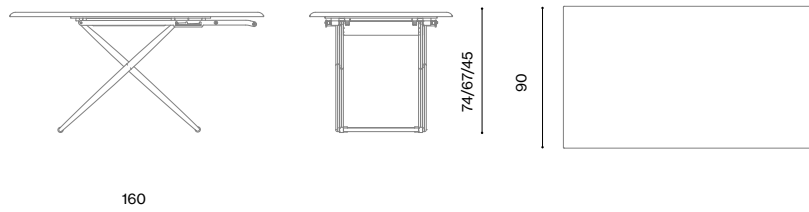

Caratteristiche / Characteristics

Tavolo Up&Down rettangolare in alluminio verniciato regolabile in 3 altezze /
Rectangular Up&Down table with three adjustable heights in paintend aluminium.
Base on wheels

Design / Design	Lievore Altherr 2016
Dimensioni / Dimensions	cm 160 x 90 x 45/64/74 h
Esterno / Outdoor	Si / yes
Struttura / Structure	Alluminio pressofuso, estruso e laminato / Die-cast, extruded aluminium and laminated
Elementi plastici / Plastic elements	Elastomero termoplastico, polipropilene, policarbonato e resine acetaliche / Thermoplastic elastomer, polypropylene, polycarbonate and acetal resins
Finitura / Paint finishes	Verniciatura polveri poliesteri o poliuretaniche/ Paint finish with polyester or polyurethane powders
Impilabilità / Stackability	No
Elementi di movimento e posizionamento	Acciaio inox/ Stainless steel
Viterie assemblaggio / Assembly screws	Acciaio inox / Stainless steel
Peso netto singolo pezzo / Net weight	52 kg
Pezzi per scatola / Units per package	1 assemblato / 1 assembled
Dimensione e volume imballo / Packaging dimension and volume	cm 164 x 102 x 55 h - 0,920 m ³
Peso lordo imballo / Gross weight package	58 kg
Garanzia / Quality guarantee	2 anni / 2 years

Descrizione / Description

Misure / Quotes

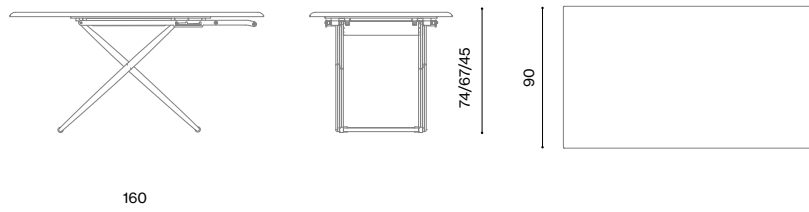

Caratteristiche / Characteristics

Tavolo Up&Down rettangolare in alluminio puntinato regolabile in 3 altezze / Rectangular Up&Down table with three adjustable heights in speckled aluminium. Base on wheels.

Design / Design	Lievore Altherr 2016
Dimensioni / Dimensions	cm 160 x 90 x 45/64/74 h
Esterno / Outdoor	Si / yes
Struttura / Structure	Alluminio pressofuso, estruso e laminato / Die-cast, extruded aluminium and laminated
Elementi plastici / Plastic elements	Elastomero termoplastico, polipropilene, policarbonato e resine acetaliche / Thermoplastic elastomer, polypropylene, polycarbonate and acetal resins
Finitura / Paint finishes	Verniciatura polveri poliesteri o poliuretaniche/ Paint finish with polyester or polyurethane powders
Impilabilità / Stackability	No
Elementi di movimento e posizionamento	Acciaio inox/ Stainless steel
Viterie assemblaggio / Assembly screws	Acciaio inox / Stainless steel
Peso netto singolo pezzo / Net weight	52 kg
Pezzi per scatola / Units per package	1 assemblato / 1 assembled
Dimensione e volume imballo / Packaging dimension and volume	cm 164 x 102 x 55 h - 0,920 m ³
Peso lordo imballo / Gross weight package	58 kg
Garanzia / Quality guarantee	2 anni / 2 years

Descrizione / Description

Misure / Quotes

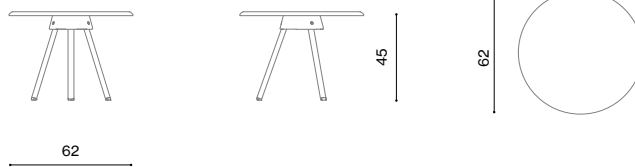

Caratteristiche / Characteristics

Coffee table in alluminio verniciato / Coffee table in painted aluminium

Design / Design	Lievore Altherr 2016
Dimensioni / Dimensions	cm Ø 62 x 45 h
Esterno / Outdoor	Si / yes
Struttura / Structure	Alluminio pressofuso, estruso e laminato / Die-cast, extruded aluminium and laminated
Elementi plastici / Plastic elements	Elastomero termoplastico e polipropilene / Thermoplastic elastomer and polypropylene
Finitura / Paint finishes	Verniciatura polveri poliesteri o poliuretaniche/ Paint finish with polyester or polyurethane powders
Impilabilità / Stackability	No
Viterie assemblaggio / Assembly screws	Acciaio inox con trattamento antisvitamento / Stainless steel with anti-unscrewing treatment
Peso netto singolo pezzo / Net weight	5,4 kg
Pezzi per scatola / Units per package	1 assemblato / 1 assembled
Dimensione e volume imballo / Packaging dimension and volume	cm 73 x 73 x 21 h - 0,112 m ³
Peso lordo imballo / Gross weight package	9 kg
Garanzia / Quality guarantee	2 anni / 2 years

Descrizione / Description

Misure / Quotes

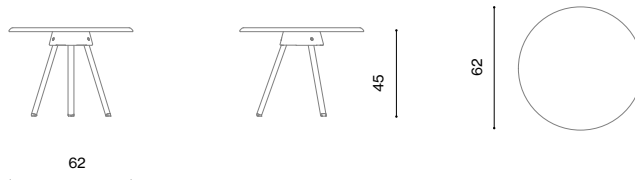

Caratteristiche / Characteristics

Coffee table in alluminio puntinato / Coffee table in speckled aluminium

Design / Design	Lievore Altherr 2016
Dimensioni / Dimensions	cm Ø 62 x 45 h
Esterno / Outdoor	Si / yes
Struttura / Structure	Alluminio pressofuso, estruso e laminato / Die-cast, extruded aluminium and laminated
Elementi plastici / Plastic elements	Elastomero termoplastico e polipropilene / Thermoplastic elastomer and polypropylene
Finitura / Paint finishes	Verniciatura polveri poliesteri o poliuretaniche/ Paint finish with polyester or polyurethane powders
Impilabilità / Stackability	No
Viterie assemblaggio / Assembly screws	Acciaio inox con trattamento antisvitamento / Stainless steel with anti-unscrewing treatment
Peso netto singolo pezzo / Net weight	5,4 kg
Pezzi per scatola / Units per package	1 assemblato / 1 assembled
Dimensione e volume imballo / Packaging dimension and volume	cm 73 x 73 x 21 h - 0,112 m ³
Peso lordo imballo / Gross weight package	9 kg
Garanzia / Quality guarantee	2 anni / 2 years

Descrizione / Description

Misure / Quotes

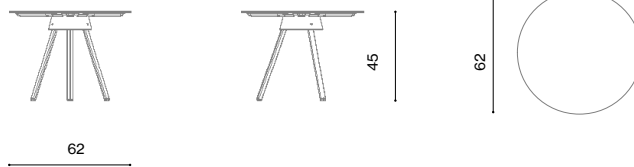

Caratteristiche / Characteristics

Coffee table in alluminio verniciato con piano in gres porcellanato (sp. 6 mm) /
Coffee table in painted aluminium with top in porcelain stoneware (th. mm 6)

Design / Design	Lievore Altherr 2023
Dimensioni / Dimensions	cm Ø 62 x 45 h
Esterno / Outdoor	Si / yes
Struttura / Structure	Alluminio pressofuso, estruso, laminato e gres porcellanato / Die-cast, extruded aluminium, laminated and porcelain stoneware
Elementi plastici / Plastic elements	Polipropilene e polietilene / Polypropylene and polyethylene
Finitura / Paint finishes	Verniciatura polveri poliesteri o poliuretaniche/ Paint finish with polyester or polyurethane powders
Impilabilità / Stackability	No
Viterie assemblaggio / Assembly screws	Acciaio inox con trattamento antisvitamento / Stainless steel with anti-unscrewing treatment
Peso netto singolo pezzo / Net weight	7 kg
Pezzi per scatola / Units per package	1 assemblato / 1 assembled
Dimensione e volume imballo / Packaging dimension and volume	cm 73 x 73 x 21 h - 0,112 m ³
Peso lordo imballo / Gross weight package	10 kg
Garanzia / Quality guarantee	2 anni / 2 years

Descrizione / Description

Misure / Quotes

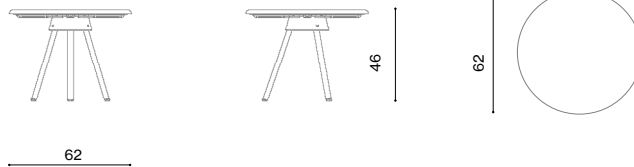
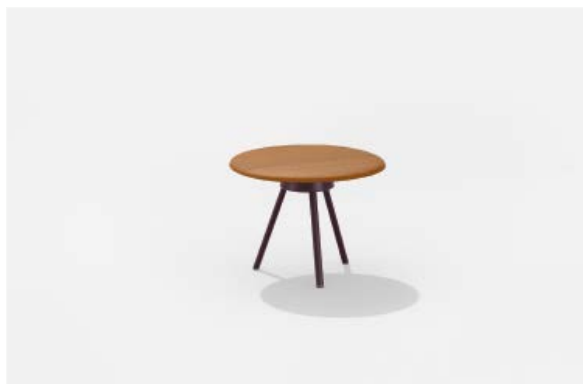

Caratteristiche / Characteristics

Coffee table in alluminio verniciato con piano in Iroko (sp. 6 mm) / Coffee table in painted aluminium with top in Iroko (th. mm 6)

Design / Design	Lievore Altherr 2023
Dimensioni / Dimensions	cm Ø 62 x 45 h
Esterno / Outdoor	Si / yes
Struttura / Structure	Alluminio pressofuso, estruso, laminato e iroko / Die-cast, extruded aluminium, laminated and iroko
Elementi plastici / Plastic elements	Polipropilene e polietilene / Polypropylene and polyethylene
Finitura / Paint finishes	Verniciatura polveri poliestere o poliuretaniche/ Paint finish with polyester or polyurethane powders
Impilabilità / Stackability	No
Viterie assemblaggio / Assembly screws	Acciaio inox con trattamento antisvitamento / Stainless steel with anti-unscrewing treatment
Peso netto singolo pezzo / Net weight	6,2 kg
Pezzi per scatola / Units per package	1 assemblato / 1 assembled
Dimensione e volume imballo / Packaging dimension and volume	cm 73 x 73 x 21 h - 0,112 m ³
Peso lordo imballo / Gross weight package	8,9 kg
Garanzia / Quality guarantee	2 anni / 2 years

Descrizione / Description

Misure / Quotes

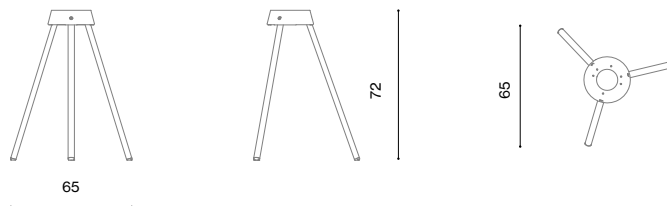

Caratteristiche / Characteristics

Base a 3 gambe in alluminio verniciato per piani tavolo da cm Ø 70 a cm Ø 80
 Three-legged painted aluminium base for table tops from Ø 70 cm to Ø 80 cm

Design / Design	Lievore Altherr 2017
Dimensioni / Dimensions	cm Ø 65 x 72 h
Esterno / Outdoor	Si / yes
Struttura / Structure	Alluminio pressofuso, estruso / Die-cast, extruded aluminium and laminated
Elementi plastici / Plastic elements	Elastomero termoplastico e polipropilene / Thermoplastic elastomer and polypropylene
Finitura / Paint finishes	Verniciatura polveri poliestere o poliuretaniche/ Paint finish with polyester or polyurethane powders
Impilabilità / Stackability	No
Viterie assemblaggio / Assembly screws	Acciaio inox con trattamento antisvitamento / Stainless steel with anti-unscrewing treatment
Peso netto singolo pezzo / Net weight	3,4 kg
Pezzi per scatola / Units per package	1 disassemblato / 1 dissembled
Dimensione e volume imballo / Packaging dimension and volume	cm 83 x 31 x 12 h - 0,030 m ³
Peso lordo imballo / Gross weight package	4,5 kg
Garanzia / Quality guarantee	2 anni / 2 years

Descrizione / Description

Misure / Quotes

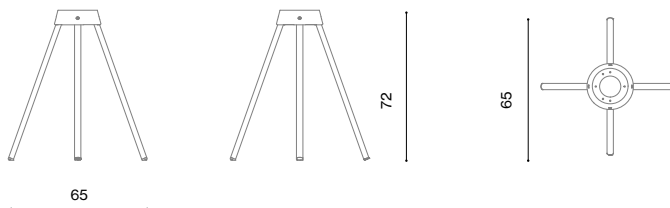

Caratteristiche / Characteristics

Base a 4 gambe in alluminio verniciato per piani tavolo da cm Ø 70 a cm Ø 90 e da cm 70x70 a cm 80x80 / Four-legged painted aluminium base for table tops from Ø 70 cm to Ø 90 cm and from 70x70 cm to 80x80 cm

Design / Design	Lievore Altherr 2017
Dimensioni / Dimensions	cm Ø 65 x 72 h
Esterno / Outdoor	Si / yes
Struttura / Structure	Alluminio pressofuso, estruso e laminato / Die-cast, extruded aluminium and laminated
Elementi plastici / Plastic elements	Elastomero termoplastico e polipropilene / Thermoplastic elastomer and polypropylene
Finitura / Paint finishes	Verniciatura polveri poliestere o poliuretatiche/ Paint finish with polyester or polyurethane powders
Impilabilità / Stackability	No
Viterie assemblaggio / Assembly screws	Acciaio inox con trattamento antisvitamento / Stainless steel with anti-unscrewing treatment
Peso netto singolo pezzo / Net weight	3,4 kg
Pezzi per scatola / Units per package	1 disassemblato / 1 dissembled
Dimensione e volume imballo / Packaging dimension and volume	cm 83 x 31 x 12 h - 0,030 m ³
Peso lordo imballo / Gross weight package	4,5 kg
Garanzia / Quality guarantee	2 anni / 2 years

Descrizione / Description

Misure / Quotes

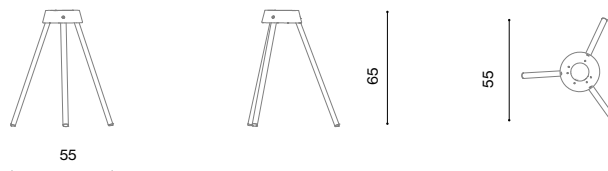

Caratteristiche / Characteristics

Base a 3 gambe in alluminio verniciato per piani tavolo max. Ø 70 cm
 Three-legged painted aluminium base for table tops max. Ø 70 cm

Design / Design	Lievore Altherr 2018
Dimensioni / Dimensions	cm Ø 55 x 65 h
Esterno / Outdoor	Si / yes
Struttura / Structure	Alluminio pressofuso, estruso e laminato / Die-cast, extruded aluminium and laminated
Elementi plastici / Plastic elements	Elastomero termoplastico e polipropilene / Thermoplastic elastomer and polypropylene
Finitura / Paint finishes	Verniciatura polveri poliestere o poliuretatiche/ Paint finish with polyester or polyurethane powders
Impilabilità / Stackability	No
Viterie assemblaggio / Assembly screws	Acciaio inox con trattamento antisvitamento / Stainless steel with anti-unscrewing treatment
Peso netto singolo pezzo / Net weight	3,2 Kg
Pezzi per scatola / Units per package	1 disassemblato / 1 dissembled
Dimensione e volume imballo / Packaging dimension and volume	cm 83 x 31 x 12 h - 0,030 m ³
Peso lordo imballo / Gross weight package	4,5 Kg
Garanzia / Quality guarantee	2 anni / 2 years

Descrizione / Description

Misure / Quotes

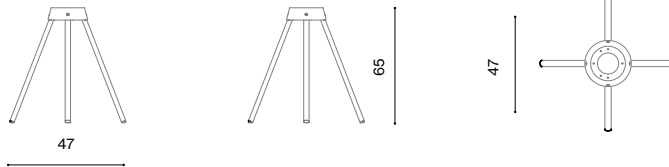

Caratteristiche / Characteristics

Base a 4 gambe in alluminio verniciato per piani tavolo da cm Ø 70 a cm Ø 90 e da cm 70x70 a cm 80x80 / Four-legged painted aluminium base for table tops from Ø 70 cm to Ø 90 cm and from 70x70 cm to 80x80 cm

Design / Design	Lievore Altherr 2018
Dimensioni / Dimensions	cm 47 x 65 x 47 h
Esterno / Outdoor	Si / yes
Struttura / Structure	Alluminio pressofuso ed estruso / Die-cast and extruded aluminium
Elementi plastici / Plastic elements	Elastomero termoplastico e polipropilene / Thermoplastic elastomer and polypropylene
Finitura / Paint finishes	Verniciatura polveri poliestere o poliuretatiche/ Paint finish with polyester or polyurethane powders
Impilabilità / Stackability	No
Viterie assemblaggio / Assembly screws	Acciaio inox con trattamento antisvitamento / Stainless steel with anti-unscrewing treatment
Peso netto singolo pezzo / Net weight	3,2 kg
Pezzi per scatola / Units per package	1 disassemblato / 1 dissembled
Dimensione e volume imballo / Packaging dimension and volume	cm 83 x 31 x 12 - 0.030 m ³
Peso lordo imballo / Gross weight package	4,5 Kg
Garanzia / Quality guarantee	2 anni / 2 years

Descrizione / Description

Misure / Quotes

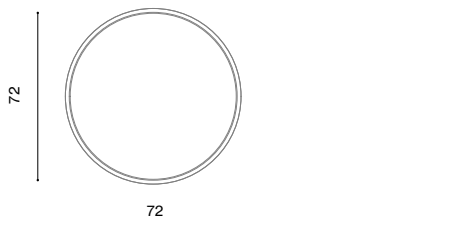

Caratteristiche / Characteristics

Piano tavolo tondo in alluminio verniciato per base Zebra
Round table top in painted aluminium for Zebra base

Design / Design	Lievore Altherr 2018
Dimensioni / Dimensions	cm Ø 72
Esterno / Outdoor	Si / yes
Struttura / Structure	Alluminio laminato / Laminated Aluminium
Elementi plastici / Plastic elements	/
Finitura / Paint finishes	Verniciatura polveri poliestere o poliuretaniche/ Paint finish with polyester or polyurethane powders
Impilabilità / Stackability	No
Viterie assemblaggio / Assembly screws	Acciaio inox con trattamento antisvitamento / Stainless steel with anti-unscrewing treatment
Peso netto singolo pezzo / Net weight	3,3 kg
Pezzi per scatola / Units per package	1 disassemblato / 1 dissembled
Dimensione e volume imballo / Packaging dimension and volume	cm 77 x 77 x 9 - 0.053 m ³
Peso lordo imballo / Gross weight package	9 Kg
Garanzia / Quality guarantee	2 anni / 2 years

Descrizione / Description

Misure / Quotes

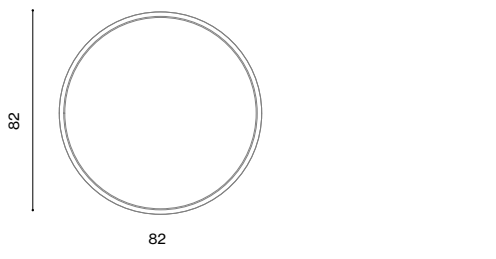
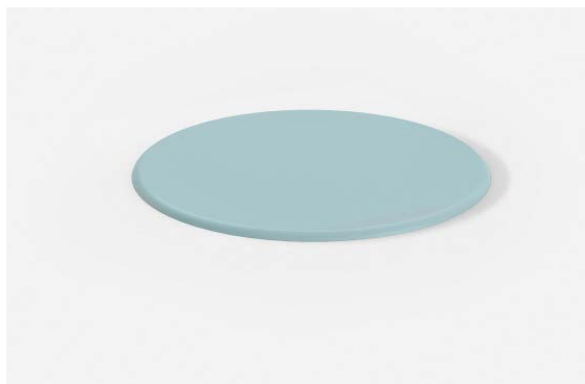

Caratteristiche / Characteristics

Piano tavolo tondo in alluminio verniciato per base Zebra
Round table top in painted aluminium for Zebra base

Design / Design	Lievore Altherr 2018
Dimensioni / Dimensions	cm Ø 82
Esterno / Outdoor	Si / yes
Struttura / Structure	Alluminio laminato / Laminated Aluminium
Elementi plastici / Plastic elements	/
Finitura / Paint finishes	Verniciatura polveri poliestere o poliuretatiche/ Paint finish with polyester or polyurethane powders
Impilabilità / Stackability	No
Viterie assemblaggio / Assembly screws	Acciaio inox con trattamento antisvitamento / Stainless steel with anti-unscrewing treatment
Peso netto singolo pezzo / Net weight	3,9 kg
Pezzi per scatola / Units per package	1 disassemblato / 1 dissembled
Dimensione e volume imballo / Packaging dimension and volume	cm 87 x 87 x 9 - 0.068 m ³
Peso lordo imballo / Gross weight package	10 Kg
Garanzia / Quality guarantee	2 anni / 2 years

Descrizione / Description

Misure / Quotes

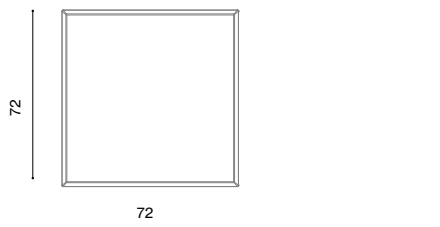

Caratteristiche / Characteristics

Piano tavolo quadrato in alluminio verniciato per base Zebra
Square table top in painted aluminium for Zebra base

Design / Design	Lievore Altherr 2018
Dimensioni / Dimensions	cm 72 x 72
Esterno / Outdoor	Si / yes
Struttura / Structure	Alluminio laminato / Laminated Aluminium
Elementi plastici / Plastic elements	/
Finitura / Paint finishes	Verniciatura polveri poliestere o poliuretaniche/ Paint finish with polyester or polyurethane powders
Impilabilità / Stackability	No
Viterie assemblaggio / Assembly screws	Acciaio inox con trattamento antisvitamento / Stainless steel with anti-unscrewing treatment
Peso netto singolo pezzo / Net weight	3,9 kg
Pezzi per scatola / Units per package	1 disassemblato / 1 dissembled
Dimensione e volume imballo / Packaging dimension and volume	cm 83 x 31 x 12 - 0.030 m ³
Peso lordo imballo / Gross weight package	9 Kg
Garanzia / Quality guarantee	2 anni / 2 years

Descrizione / Description

Misure / Quotes

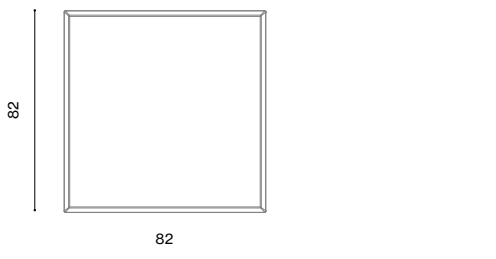
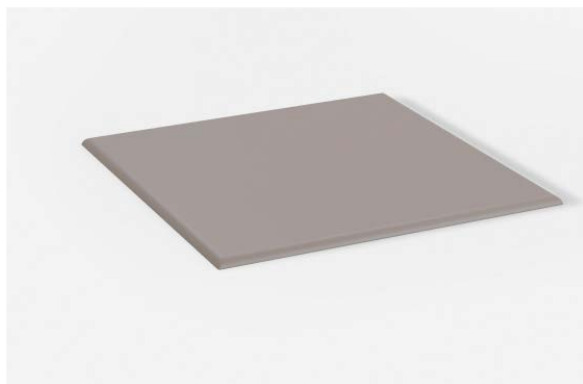

Caratteristiche / Characteristics

Piano tavolo quadrato in alluminio verniciato perbase Zebra
Square table top in painted aluminium for Zebra base

Design / Design	Lievore Altherr 2018
Dimensioni / Dimensions	cm W82 x 82
Esterno / Outdoor	Si / yes
Struttura / Structure	Alluminio laminato / Laminated Aluminium
Elementi plastici / Plastic elements	/
Finitura / Paint finishes	Verniciatura polveri poliestere o poliuretatiche/ Paint finish with polyester or polyurethane powders
Impilabilità / Stackability	No
Viterie assemblaggio / Assembly screws	Acciaio inox con trattamento antisvitamento / Stainless steel with anti-unscrewing treatment
Peso netto singolo pezzo / Net weight	4,8 kg
Pezzi per scatola / Units per package	1 disassemblato / 1 dissembled
Dimensione e volume imballo / Packaging dimension and volume	cm 87 x 87 x 9 - 0.068 m ³
Peso lordo imballo / Gross weight package	12 Kg
Garanzia / Quality guarantee	2 anni / 2 years

Descrizione / Description

Misure / Quotes

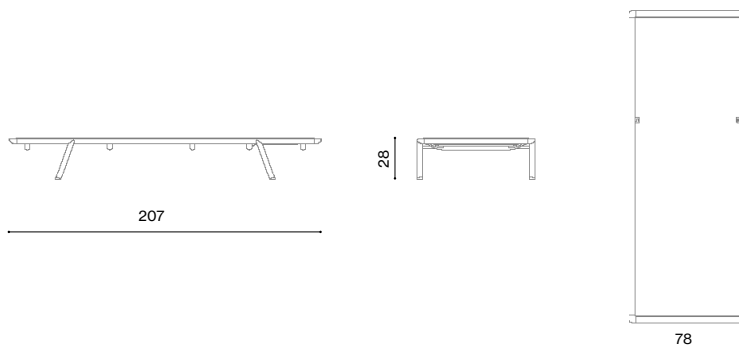

Caratteristiche / Characteristics

Letto in alluminio verniciato e tessuto Batyline / Sunlounger in painted aluminium and Batyline fabric

Design / Design	Lievore Altherr 2023
Dimensioni / Dimensions	cm 207 x 78 x 28 h
Esterno / Outdoor	Si / yes
Struttura / Structure	Alluminio pressofuso e estruso / Die-cast, extruded and laminated aluminium
Telo / Textile	Composito PVC / PVC composite
Elementi plastici / Plastic elements	Polipropilene e polietilene / Polypropylene and polyethylene
Finitura / Paint finishes	Verniciatura polveri poliestere o poliuretatiche / Paint finish with polyester or polyurethane powders
Impilabilità / Stackability	No
Viterie assemblaggio / Assembly screws	Acciaio inox con trattamento antisvitamento / Stainless steel with anti-unscrewing treatment
Peso netto singolo pezzo / Net weight	12,8 kg
Pezzi per scatola / Units per package	1 assemblato / 1 assembled
Dimensione e volume imballo / Packaging dimension and volume	cm 220 x 94 x 46 - 0.951 m ³
Peso lordo imballo / Gross weight package	33 Kg
Garanzia / Quality guarantee	2 anni / 2 years

Accessori / Accessories



644

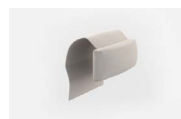

645

Descrizione / Description

Misure / Quotes

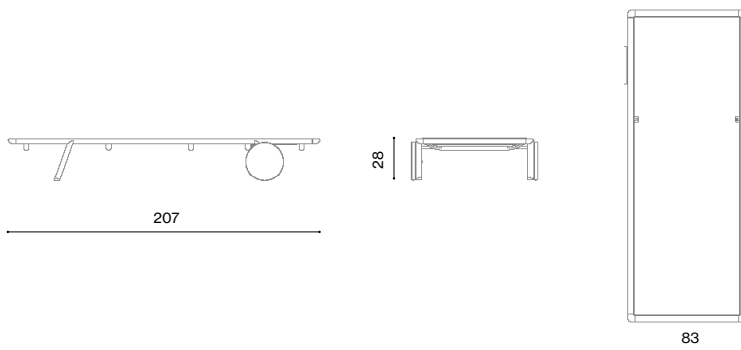

Caratteristiche / Characteristics

Letto in alluminio verniciato e tessuto Batyline con ruote / Sunlounger in painted aluminium and Batyline fabric with castors

Design / Design	Lievore Altherr 2023
Dimensioni / Dimensions	cm 207 x 83 x 28 h
Esterno / Outdoor	Si / yes
Struttura / Structure	Alluminio pressofuso e estruso / Die-cast, extruded and laminated aluminium
Telo / Textile	Composito PVC / PVC composite
Elementi plastici / Plastic elements	Polipropilene e polietilene / Polypropylene and polyethylene
Finitura / Paint finishes	Verniciatura polveri poliestere o poliuretatiche / Paint finish with polyester or polyurethane powders
Impilabilità / Stackability	No
Viterie assemblaggio / Assembly screws	Acciaio inox con trattamento antisvitamento / Stainless steel with anti-unscrewing treatment
Peso netto singolo pezzo / Net weight	16 kg
Pezzi per scatola / Units per package	1 assemblato / 1 assembled
Dimensione e volume imballo / Packaging dimension and volume	cm 220 x 94 x 46 - 0.951 m ³
Peso lordo imballo / Gross weight package	36,2 Kg
Garanzia / Quality guarantee	2 anni / 2 years

Accessori / Accessories



644

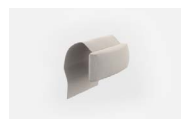

645

Manutenzione / Maintenance

Alluminio: Alluminio verniciato: Le operazioni di ordinaria pulizia per l'alluminio verniciato vanno eseguite con acqua tiepida e detergente neutro, utilizzando un panno morbido, evitando l'utilizzo di prodotti abrasivi, aggressivi, a base acida o alcalina.

Gres porcellanato: Le operazioni di ordinaria pulizia del gres porcellanato vanno eseguite con acqua tiepida e detergente neutro, utilizzando un panno morbido, evitando l'utilizzo di prodotti abrasivi, aggressivi, a base acida o alcalina e contenenti cere.

Iroko: Le operazioni di ordinaria pulizia dell'Iroko vanno eseguite con acqua e sapone liquido a PH neutro, utilizzando un panno morbido leggermente inumidito, si consiglia il kit KTEAKO2. E' suggerita la rimozione immediata di residui di bevande, cibi, foglie, fiori ed escrementi di uccelli.

Si consiglia di fare manutenzione due o più volte all'anno, osservando anche il naturale ingrigimento del tavolo, con kit KTEAKO2, seguendo le istruzioni al suo interno.

Batyline: Le operazioni di ordinaria pulizia per il batyline vanno eseguite con lo spray

SPRAY01, spruzzandolo sulla superficie del telo, lasciare agire e risciacquare con acqua tiepida.

Aluminium: Painted aluminium: Perform routine cleaning on painted aluminium with warm water and neutral detergent, using a soft cloth. Do not use aggressive, abrasive, acid- or alkalibased products.

Porcelain stoneware: Perform routine cleaning on porcelain stoneware with warm water and neutral detergent, using a soft cloth. Do not use aggressive, abrasive, acid- or alkalibased products, nor products that contain waxes.

Iroko: Routine cleaning of Iroko should be carried out with water and neutral PH liquid soap, using a soft, slightly damp cloth. We recommend the KTEAKO2 kit. Immediate removal of drink residues, food, leaves, flowers and bird droppings is recommended.

It is advisable to carry out maintenance twice or more times a year, also observing the natural greying of the table, with a KTEAKO2 kit, following the instructions found inside

Batyline: Perform routine cleaning on batyline using the spray SPRAY01. Spray it on the sunbed textile, leave to act and rinse it with lukewarm water.