

# ZEBRA

Design Studio Lievore Altherr



<sup>IT</sup> Realizzata in alluminio pressofuso, la collezione Zebra unisce la solidità del materiale alla leggerezza delle forme e, per questo, si adatta facilmente agli ambienti outdoor residenziali o contract. Nelle sedute, le linee gestuali dello schienale ricreano quell'effetto organico e irregolare caratteristico delle venature del legno e della pietra.

<sup>EN</sup> Made in die cast aluminium, the collection Zebra combines the solidity of the material with the light weight of the shapes, hence, adapts easily to any outdoor setting, be it residential or contract. The gestural backrest pattern evokes the organic feel of wood grain or a mineral veins - perfectly irregular, perfectly natural.

# FAST

## Descrizione / Description

## Misure / Quotes

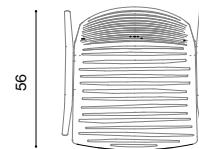
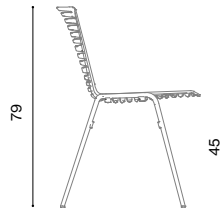

## Caratteristiche / Characteristics

Sedia in alluminio verniciato / Chair in painted aluminium

Design / Design	Lievore Altherr   2016
Dimensioni / Dimensions	cm 57 x 56 x 45 / 79
Esterno / Outdoor	Si / yes
Struttura / Structure	Alluminio pressofuso / Die-cast aluminium
Elementi plastici / Plastic elements	Elastomero termoplastico e polipropilene / Thermoplastic elastomer and polypropylene
Finitura / Paint finishes	Verniciatura polveri poliesteri o poliuretaniche/ Paint finish with polyester or polyurethane powders
Impilabilità / Stackability	Si (6 pezzi) / yes (6 pieces)
Viterie assemblaggio / Assembly screws	Acciaio inox con trattamento antisvitamento / Stainless steel with anti-unscrewing treatment
Peso netto singolo pezzo / Net weight	6.5 kg
Pezzi per scatola / Units per package	2 assemblati / 2 assembled
Dimensione e volume imballo / Packaging dimension and volume	cm 73 x 69 x 96 h - 0,483 m <sup>3</sup>
Peso lordo imballo / Gross weight package	21 kg
Garanzia / Quality guarantee	2 anni / 2 years

## Accessori / Accessories



624



625

## Descrizione / Description

## Misure / Quotes

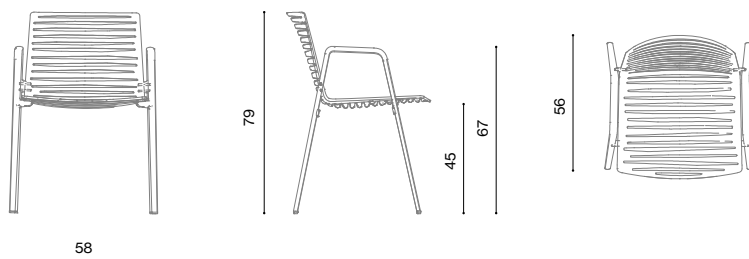

## Caratteristiche / Characteristics

Sedia con braccioli in alluminio verniciato / Chair with armrests in painted aluminum

Design / Design	Lievore Altherr   2016
Dimensioni / Dimensions	cm 58 x 56 x 45 /67/ 79 h
Esterno / Outdoor	Si / yes
Struttura / Structure	Alluminio pressofuso / Die-cast aluminium
Elementi plastici / Plastic elements	Elastomero termoplastico e polipropilene / Thermoplastic elastomer and polypropylene
Finitura / Paint finishes	Verniciatura polveri poliesteri o poliuretaniche/ Paint finish with polyester or polyurethane powders
Impilabilità / Stackability	Si (6 pezzi) / yes (6 pieces)
Viterie assemblaggio / Assembly screws	Acciaio inox con trattamento antisvitamento / Stainless steel with anti-unscrewing treatment
Peso netto singolo pezzo / Net weight	7.2 kg
Pezzi per scatola / Units per package	2 assemblati / 2 assembled
Dimensione e volume imballo / Packaging dimension and volume	cm 73 x 69 x 96 h - 0,483 m <sup>3</sup>
Peso lordo imballo / Gross weight package	22 kg
Garanzia / Quality guarantee	2 anni / 2 years

## Accessori / Accessories



626



627

## Descrizione / Description

## Misure / Quotes

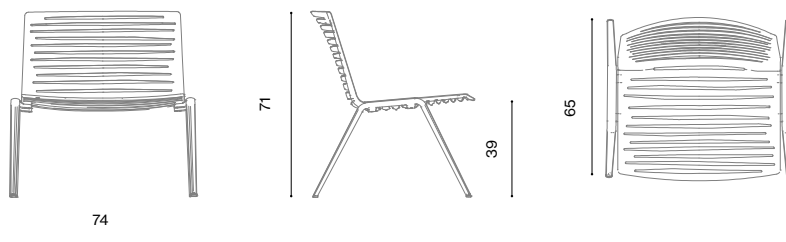

## Caratteristiche / Characteristics

Poltrona lounge in alluminio verniciato / Lounge armchair in painted aluminium

Design / Design	Lievore Altherr   2018
Dimensioni / Dimensions	cm 74 x 65 x 39/71 h
Esterno / Outdoor	Si / yes
Struttura / Structure	Alluminio pressofuso / Die-cast aluminium
Elementi plastici / Plastic elements	Elastomero termoplastico e polipropilene / Thermoplastic elastomer and polypropylene
Finitura / Paint finishes	Verniciatura polveri poliesteri o poliuretaniche/ Paint finish with polyester or polyurethane powders
Impilabilità / Stackability	No
Viterie assemblaggio / Assembly screws	Acciaio inox / Stainless steel
Peso netto singolo pezzo / Net weight	10,22 kg
Pezzi per scatola / Units per package	1 assemblato / 1 assembled
Dimensione e volume imballo / Packaging dimension and volume	100 x 86 x 80 cm - 0.688 m <sup>3</sup>
Peso lordo imballo / Gross weight package	20 kg
Garanzia / Quality guarantee	2 anni / 2 years
Accessori / Accessories	



628

## Descrizione / Description

## Misure / Quotes



## Caratteristiche / Characteristics

Poggiapiedi in alluminio verniciato /Footrest in painted aluminium

## Design / Design

Lievore Altherr | 2018

## Dimensioni / Dimensions

cm 67 x 62 x 36/39 h

## Esterno / Outdoor

Si / yes

## Struttura / Structure

Alluminio pressofuso e laminato / Die-cast and laminated aluminium

## Elementi plastici / Plastic elements

Elastomero termoplastico e polipropilene / Thermoplastic elastomer and polypropylene

## Finitura / Paint finishes

Verniciatura polveri poliesteri o poliuretaniche/ Paint finish with polyester or polyurethane powders

## Impilabilità / Stackability

No

## Viterie assemblaggio / Assembly screws

Acciaio inox / Stainless steel

## Peso netto singolo pezzo / Net weight

8 kg

## Pezzi per scatola / Units per package

1 assemblato / 1 assembled

## Dimensione e volume imballo / Packaging dimension and volume

73 x 52 x 97 cm - 0.368 m<sup>3</sup>

## Peso lordo imballo / Gross weight package

12 kg

## Garanzia / Quality guarantee

2 anni / 2 years

## Accessori / Accessories



628

## Descrizione / Description

## Misure / Quotes

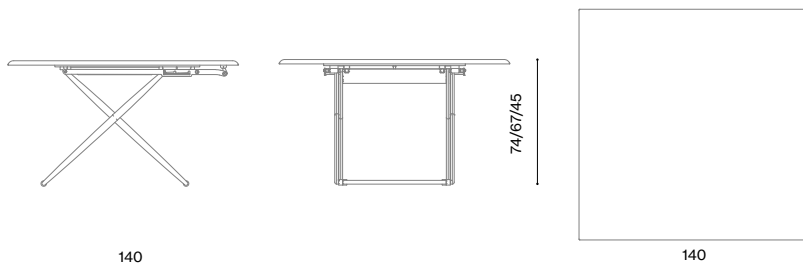

## Caratteristiche / Characteristics

Tavolo Up&Down quadrato in alluminio verniciato regolabile in 3 altezze / Square Up&Down table with three adjustable heights in painted aluminium. Base on wheels

Design / Design	Lievore Altherr   2016
Dimensioni / Dimensions	cm 140 x 140 x 45/64/74 h
Esterno / Outdoor	Si / yes
Struttura / Structure	Alluminio pressofuso, estruso e laminato / Die-cast, extruded aluminium and laminated
Elementi plastici / Plastic elements	Elastomero termoplastico, polipropilene, policarbonato e resine acetaliche / Thermoplastic elastomer, polypropylene, polycarbonate and acetal resins
Finitura / Paint finishes	Verniciatura polveri poliesteri o poliuretaniche/ Paint finish with polyester or polyurethane powders
Impilabilità / Stackability	No
Elementi di movimento e posizionamento	Acciaio inox/ Stainless steel
Viterie assemblaggio / Assembly screws	Acciaio inox / Stainless steel
Peso netto singolo pezzo / Net weight	53,2 kg
Pezzi per scatola / Units per package	1 assemblato / 1 assembled
Dimensione e volume imballo / Packaging dimension and volume	cm 153 x 153 x 55 h - 1,287 m <sup>3</sup>
Peso lordo imballo / Gross weight package	59 kg
Garanzia / Quality guarantee	2 anni / 2 years

## Descrizione / Description

## Misure / Quotes

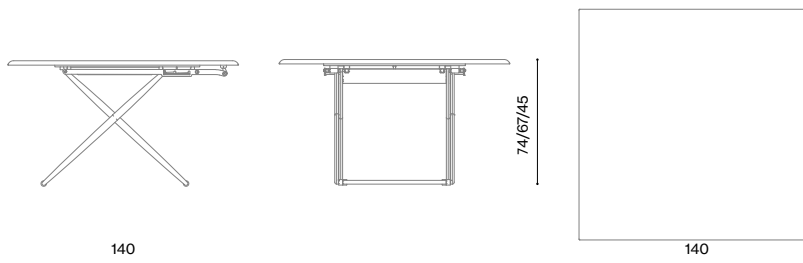

## Caratteristiche / Characteristics

Tavolo Up&Down quadrato in alluminio verniciato regolabile in 3 altezze con piano in alluminio puntinato. Base su ruote. / Square Up&Down table with three adjustable heights in speckled aluminium. Base on wheels.

Design / Design	Lievore Altherr   2016
Dimensioni / Dimensions	cm 140 x 140 x 45/64/74 h
Esterno / Outdoor	Si / yes
Struttura / Structure	Alluminio pressofuso, estruso e laminato / Die-cast, extruded aluminium and laminated
Elementi plastici / Plastic elements	Elastomero termoplastico, polipropilene, policarbonato e resine acetaliche / Thermoplastic elastomer, polypropylene, polycarbonate and acetal resins
Finitura / Paint finishes	Verniciatura polveri poliesteri o poliuretaniche/ Paint finish with polyester or polyurethane powders
Impilabilità / Stackability	No
Elementi di movimento e posizionamento	Acciaio inox/ Stainless steel
Viterie assemblaggio / Assembly screws	Acciaio inox / Stainless steel
Peso netto singolo pezzo / Net weight	53,2 kg
Pezzi per scatola / Units per package	1 assemblato / 1 assembled
Dimensione e volume imballo / Packaging dimension and volume	cm 153 x 153 x 55 h - 1,287 m <sup>3</sup>
Peso lordo imballo / Gross weight package	59 kg
Garanzia / Quality guarantee	2 anni / 2 years

## Descrizione / Description

## Misure / Quotes

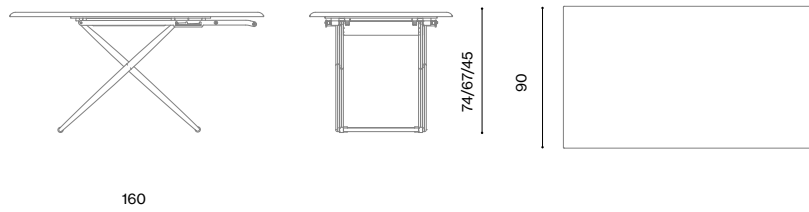

## Caratteristiche / Characteristics

Tavolo Up&Down rettangolare in alluminio verniciato regolabile in 3 altezze /  
Rectangular Up&Down table with three adjustable heights in paintend aluminium.  
Base on wheels

Design / Design	Lievore Altherr   2016
Dimensioni / Dimensions	cm 160 x 90 x 45/64/74 h
Esterno / Outdoor	Si / yes
Struttura / Structure	Alluminio pressofuso, estruso e laminato / Die-cast, extruded aluminium and laminated
Elementi plastici / Plastic elements	Elastomero termoplastico, polipropilene, policarbonato e resine acetaliche / Thermoplastic elastomer, polypropylene, polycarbonate and acetal resins
Finitura / Paint finishes	Verniciatura polveri poliesteri o poliuretaniche/ Paint finish with polyester or polyurethane powders
Impilabilità / Stackability	No
Elementi di movimento e posizionamento	Acciaio inox/ Stainless steel
Viterie assemblaggio / Assembly screws	Acciaio inox / Stainless steel
Peso netto singolo pezzo / Net weight	52 kg
Pezzi per scatola / Units per package	1 assemblato / 1 assembled
Dimensione e volume imballo / Packaging dimension and volume	cm 164 x 102 x 55 h - 0,920 m <sup>3</sup>
Peso lordo imballo / Gross weight package	58 kg
Garanzia / Quality guarantee	2 anni / 2 years



## Descrizione / Description

## Misure / Quotes

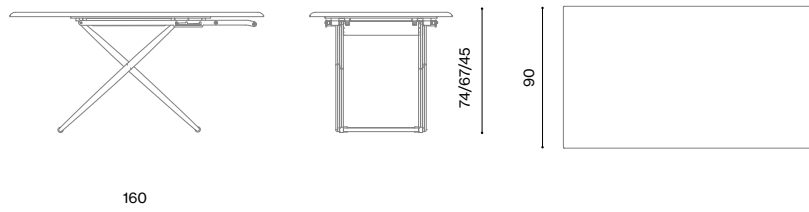

## Caratteristiche / Characteristics

Tavolo Up&Down rettangolare in alluminio puntinato regolabile in 3 altezze / Rectangular Up&Down table with three adjustable heights in speckled aluminium. Base on wheels.

Design / Design	Lievore Altherr   2016
Dimensioni / Dimensions	cm 160 x 90 x 45/64/74 h
Esterno / Outdoor	Si / yes
Struttura / Structure	Alluminio pressofuso, estruso e laminato / Die-cast, extruded aluminium and laminated
Elementi plastici / Plastic elements	Elastomero termoplastico, polipropilene, policarbonato e resine acetaliche / Thermoplastic elastomer, polypropylene, polycarbonate and acetal resins
Finitura / Paint finishes	Verniciatura polveri poliesteri o poliuretaniche/ Paint finish with polyester or polyurethane powders
Impilabilità / Stackability	No
Elementi di movimento e posizionamento	Acciaio inox/ Stainless steel
Viterie assemblaggio / Assembly screws	Acciaio inox / Stainless steel
Peso netto singolo pezzo / Net weight	52 kg
Pezzi per scatola / Units per package	1 assemblato / 1 assembled
Dimensione e volume imballo / Packaging dimension and volume	cm 164 x 102 x 55 h - 0,920 m <sup>3</sup>
Peso lordo imballo / Gross weight package	58 kg
Garanzia / Quality guarantee	2 anni / 2 years

## Descrizione / Description

## Misure / Quotes

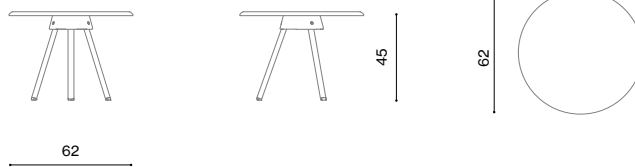

## Caratteristiche / Characteristics

Coffee table in alluminio verniciato / Coffee table in painted aluminium

Design / Design	Lievore Altherr   2016
Dimensioni / Dimensions	cm Ø 62 x 45 h
Esterno / Outdoor	Si / yes
Struttura / Structure	Alluminio pressofuso, estruso e laminato / Die-cast, extruded aluminium and laminated
Elementi plastici / Plastic elements	Elastomero termoplastico e polipropilene / Thermoplastic elastomer and polypropylene
Finitura / Paint finishes	Verniciatura polveri poliesteri o poliuretaniche/ Paint finish with polyester or polyurethane powders
Impilabilità / Stackability	No
Viterie assemblaggio / Assembly screws	Acciaio inox con trattamento antisvitamento / Stainless steel with anti-unscrewing treatment
Peso netto singolo pezzo / Net weight	5,4 kg
Pezzi per scatola / Units per package	1 assemblato / 1 assembled
Dimensione e volume imballo / Packaging dimension and volume	cm 73 x 73 x 21 h - 0,112 m <sup>3</sup>
Peso lordo imballo / Gross weight package	9 kg
Garanzia / Quality guarantee	2 anni / 2 years

## Descrizione / Description

## Misure / Quotes

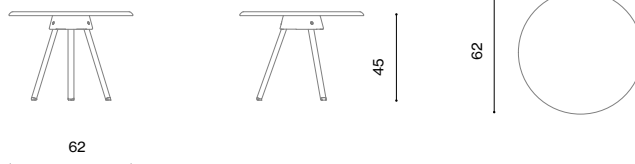

## Caratteristiche / Characteristics

Coffee table in alluminio puntinato / Coffee table in speckled aluminium

Design / Design	Lievore Altherr   2016
Dimensioni / Dimensions	cm Ø 62 x 45 h
Esterno / Outdoor	Si / yes
Struttura / Structure	Alluminio pressofuso, estruso e laminato / Die-cast, extruded aluminium and laminated
Elementi plastici / Plastic elements	Elastomero termoplastico e polipropilene / Thermoplastic elastomer and polypropylene
Finitura / Paint finishes	Verniciatura polveri poliesteri o poliuretaniche/ Paint finish with polyester or polyurethane powders
Impilabilità / Stackability	No
Viterie assemblaggio / Assembly screws	Acciaio inox con trattamento antisvitamento / Stainless steel with anti-unscrewing treatment
Peso netto singolo pezzo / Net weight	5,4 kg
Pezzi per scatola / Units per package	1 assemblato / 1 assembled
Dimensione e volume imballo / Packaging dimension and volume	cm 73 x 73 x 21 h - 0,112 m <sup>3</sup>
Peso lordo imballo / Gross weight package	9 kg
Garanzia / Quality guarantee	2 anni / 2 years

## Descrizione / Description

## Misure / Quotes

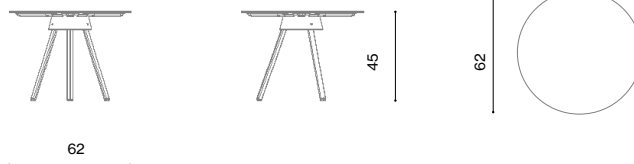

## Caratteristiche / Characteristics

Coffee table in alluminio verniciato con piano in gres porcellanato (sp. 6 mm) /  
Coffee table in painted aluminium with top in porcelain stoneware (th. mm 6)

Design / Design	Lievore Altherr   2023
Dimensioni / Dimensions	cm Ø 62 x 45 h
Esterno / Outdoor	Si / yes
Struttura / Structure	Alluminio pressofuso, estruso, laminato e gres porcellanato / Die-cast, extruded aluminium, laminated and porcelain stoneware
Elementi plastici / Plastic elements	Polipropilene e polietilene / Polypropylene and polyethylene
Finitura / Paint finishes	Verniciatura polveri poliesteri o poliuretaniche/ Paint finish with polyester or polyurethane powders
Impilabilità / Stackability	No
Viterie assemblaggio / Assembly screws	Acciaio inox con trattamento antisvitamento / Stainless steel with anti-unscrewing treatment
Peso netto singolo pezzo / Net weight	7 kg
Pezzi per scatola / Units per package	1 assemblato / 1 assembled
Dimensione e volume imballo / Packaging dimension and volume	cm 73 x 73 x 21 h - 0,112 m <sup>3</sup>
Peso lordo imballo / Gross weight package	10 kg
Garanzia / Quality guarantee	2 anni / 2 years

## Descrizione / Description

## Misure / Quotes

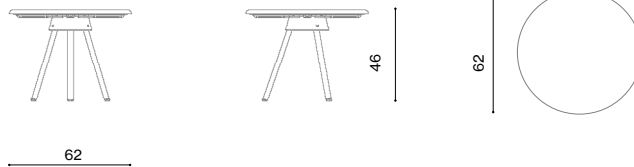
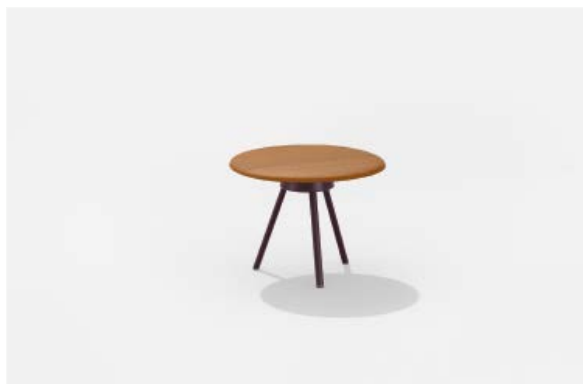

## Caratteristiche / Characteristics

Coffee table in alluminio verniciato con piano in Iroko (sp. 6 mm) / Coffee table in painted aluminium with top in Iroko (th. mm 6)

Design / Design	Lievore Altherr   2023
Dimensioni / Dimensions	cm Ø 62 x 45 h
Esterno / Outdoor	Si / yes
Struttura / Structure	Alluminio pressofuso, estruso, laminato e iroko / Die-cast, extruded aluminium, laminated and iroko
Elementi plastici / Plastic elements	Polipropilene e polietilene / Polypropylene and polyethylene
Finitura / Paint finishes	Verniciatura polveri poliesteri o poliuretaniche/ Paint finish with polyester or polyurethane powders
Impilabilità / Stackability	No
Viterie assemblaggio / Assembly screws	Acciaio inox con trattamento antisvitamento / Stainless steel with anti-unscrewing treatment
Peso netto singolo pezzo / Net weight	6,2 kg
Pezzi per scatola / Units per package	1 assemblato / 1 assembled
Dimensione e volume imballo / Packaging dimension and volume	cm 73 x 73 x 21 h - 0,112 m <sup>3</sup>
Peso lordo imballo / Gross weight package	8,9 kg
Garanzia / Quality guarantee	2 anni / 2 years

## Descrizione / Description

## Misure / Quotes

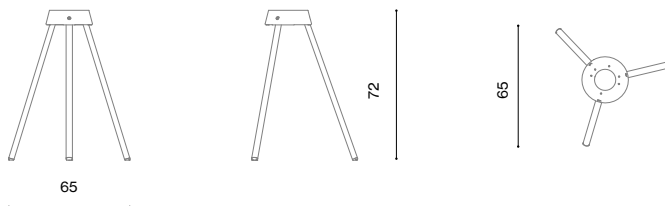

## Caratteristiche / Characteristics

Base a 3 gambe in alluminio verniciato per piani tavolo da cm Ø 70 a cm Ø 80  
 Three-legged painted aluminium base for table tops from Ø 70 cm to Ø 80 cm

Design / Design	Lievore Altherr   2017
Dimensioni / Dimensions	cm Ø 65 x 72 h
Esterno / Outdoor	Si / yes
Struttura / Structure	Alluminio pressofuso, estruso / Die-cast, extruded aluminium and laminated
Elementi plastici / Plastic elements	Elastomero termoplastico e polipropilene / Thermoplastic elastomer and polypropylene
Finitura / Paint finishes	Verniciatura polveri poliestere o poliuretaniche/ Paint finish with polyester or polyurethane powders
Impilabilità / Stackability	No
Viterie assemblaggio / Assembly screws	Acciaio inox con trattamento antisvitamento / Stainless steel with anti-unscrewing treatment
Peso netto singolo pezzo / Net weight	3,4 kg
Pezzi per scatola / Units per package	1 disassemblato / 1 dissembled
Dimensione e volume imballo / Packaging dimension and volume	cm 83 x 31 x 12 h - 0,030 m <sup>3</sup>
Peso lordo imballo / Gross weight package	4,5 kg
Garanzia / Quality guarantee	2 anni / 2 years

## Descrizione / Description

## Misure / Quotes

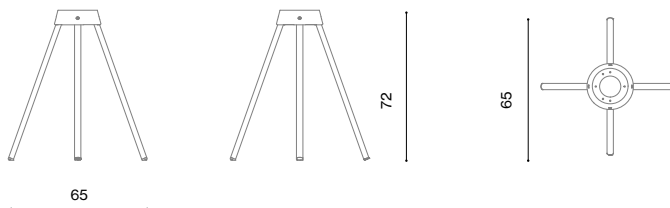

## Caratteristiche / Characteristics

Base a 4 gambe in alluminio verniciato per piani tavolo da cm Ø 70 a cm Ø 90 e da cm 70x70 a cm 80x80 / Four-legged painted aluminium base for table tops from Ø 70 cm to Ø 90 cm and from 70x70 cm to 80x80 cm

Design / Design	Lievore Altherr   2017
Dimensioni / Dimensions	cm Ø 65 x 72 h
Esterno / Outdoor	Si / yes
Struttura / Structure	Alluminio pressofuso, estruso e laminato / Die-cast, extruded aluminium and laminated
Elementi plastici / Plastic elements	Elastomero termoplastico e polipropilene / Thermoplastic elastomer and polypropylene
Finitura / Paint finishes	Verniciatura polveri poliestere o poliuretatiche/ Paint finish with polyester or polyurethane powders
Impilabilità / Stackability	No
Viterie assemblaggio / Assembly screws	Acciaio inox con trattamento antisvitamento / Stainless steel with anti-unscrewing treatment
Peso netto singolo pezzo / Net weight	3,4 kg
Pezzi per scatola / Units per package	1 disassemblato / 1 dissembled
Dimensione e volume imballo / Packaging dimension and volume	cm 83 x 31 x 12 h - 0,030 m <sup>3</sup>
Peso lordo imballo / Gross weight package	4,5 kg
Garanzia / Quality guarantee	2 anni / 2 years

## Descrizione / Description

## Misure / Quotes

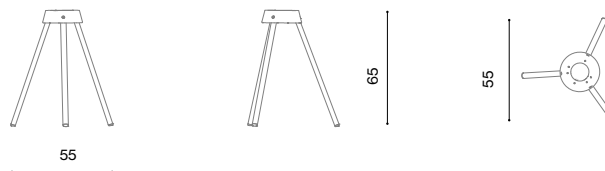

## Caratteristiche / Characteristics

Base a 3 gambe in alluminio verniciato per piani tavolo max. Ø 70 cm  
 Three-legged painted aluminium base for table tops max. Ø 70 cm

Design / Design	Lievore Altherr   2018
Dimensioni / Dimensions	cm Ø 55 x 65 h
Esterno / Outdoor	Si / yes
Struttura / Structure	Alluminio pressofuso, estruso e laminato / Die-cast, extruded aluminium and laminated
Elementi plastici / Plastic elements	Elastomero termoplastico e polipropilene / Thermoplastic elastomer and polypropylene
Finitura / Paint finishes	Verniciatura polveri poliesteri o poliuretaniche/ Paint finish with polyester or polyurethane powders
Impilabilità / Stackability	No
Viterie assemblaggio / Assembly screws	Acciaio inox con trattamento antisvitamento / Stainless steel with anti-unscrewing treatment
Peso netto singolo pezzo / Net weight	3,2 Kg
Pezzi per scatola / Units per package	1 disassemblato / 1 dissembled
Dimensione e volume imballo / Packaging dimension and volume	cm 83 x 31 x 12 h - 0,030 m <sup>3</sup>
Peso lordo imballo / Gross weight package	4,5 Kg
Garanzia / Quality guarantee	2 anni / 2 years



## Descrizione / Description

## Misure / Quotes

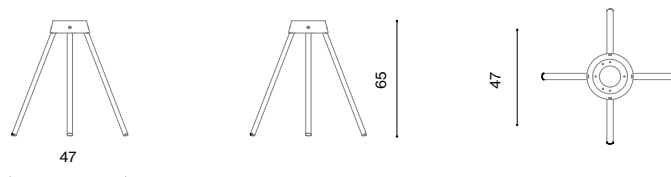

## Caratteristiche / Characteristics

Base a 4 gambe in alluminio verniciato per piani tavolo da cm Ø 70 a cm Ø 90 e da cm 70x70 a cm 80x80 / Four-legged painted aluminium base for table tops from Ø 70 cm to Ø 90 cm and from 70x70 cm to 80x80 cm

Design / Design	Lievore Altherr   2018
Dimensioni / Dimensions	cm 47 x 65 x 47 h
Esterno / Outdoor	Si / yes
Struttura / Structure	Alluminio pressofuso ed estruso / Die-cast and extruded aluminium
Elementi plastici / Plastic elements	Elastomero termoplastico e polipropilene / Thermoplastic elastomer and polypropylene
Finitura / Paint finishes	Verniciatura polveri poliestere o poliuretatiche/ Paint finish with polyester or polyurethane powders
Impilabilità / Stackability	No
Viterie assemblaggio / Assembly screws	Acciaio inox con trattamento antisvitamento / Stainless steel with anti-unscrewing treatment
Peso netto singolo pezzo / Net weight	3,2 kg
Pezzi per scatola / Units per package	1 disassemblato / 1 dissembled
Dimensione e volume imballo / Packaging dimension and volume	cm 83 x 31 x 12 - 0.030 m <sup>3</sup>
Peso lordo imballo / Gross weight package	4,5 Kg
Garanzia / Quality guarantee	2 anni / 2 years

## Descrizione / Description

## Misure / Quotes

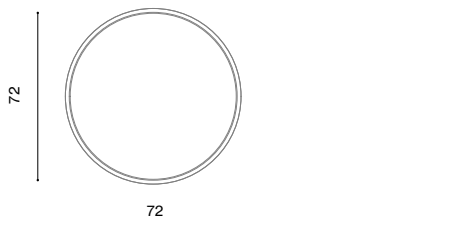

## Caratteristiche / Characteristics

Piano tavolo tondo in alluminio verniciato per base Zebra  
Round table top in painted aluminium for Zebra base

Design / Design	Lievore Altherr   2018
Dimensioni / Dimensions	cm Ø 72
Esterno / Outdoor	Si / yes
Struttura / Structure	Alluminio laminato / Laminated Aluminium
Elementi plastici / Plastic elements	/
Finitura / Paint finishes	Verniciatura polveri poliestere o poliuretatiche/ Paint finish with polyester or polyurethane powders
Impilabilità / Stackability	No
Viterie assemblaggio / Assembly screws	Acciaio inox con trattamento antisvitamento / Stainless steel with anti-unscrewing treatment
Peso netto singolo pezzo / Net weight	3,3 kg
Pezzi per scatola / Units per package	1 disassemblato / 1 dissembled
Dimensione e volume imballo / Packaging dimension and volume	cm 77 x 77 x 9 - 0.053 m <sup>3</sup>
Peso lordo imballo / Gross weight package	9 Kg
Garanzia / Quality guarantee	2 anni / 2 years

## Descrizione / Description

## Misure / Quotes

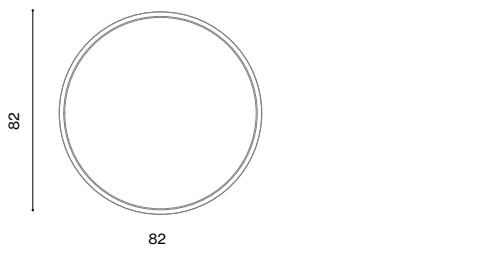
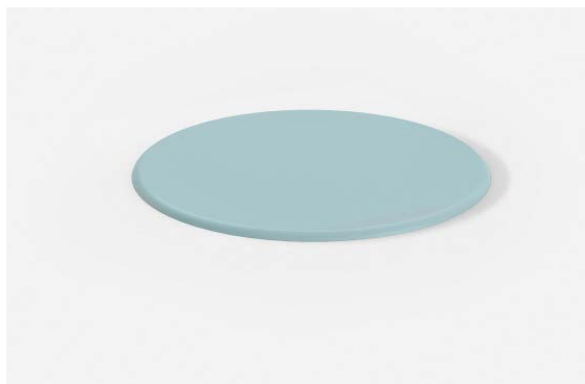

## Caratteristiche / Characteristics

Piano tavolo tondo in alluminio verniciato per base Zebra  
Round table top in painted aluminium for Zebra base

Design / Design	Lievore Altherr   2018
Dimensioni / Dimensions	cm Ø 82
Esterno / Outdoor	Si / yes
Struttura / Structure	Alluminio laminato / Laminated Aluminium
Elementi plastici / Plastic elements	/
Finitura / Paint finishes	Verniciatura polveri poliestere o poliuretaniche/ Paint finish with polyester or polyurethane powders
Impilabilità / Stackability	No
Viterie assemblaggio / Assembly screws	Acciaio inox con trattamento antisvitamento / Stainless steel with anti-unscrewing treatment
Peso netto singolo pezzo / Net weight	3,9 kg
Pezzi per scatola / Units per package	1 disassemblato / 1 dissembled
Dimensione e volume imballo / Packaging dimension and volume	cm 87 x 87 x 9 - 0.068 m <sup>3</sup>
Peso lordo imballo / Gross weight package	10 Kg
Garanzia / Quality guarantee	2 anni / 2 years

## Descrizione / Description

## Misure / Quotes

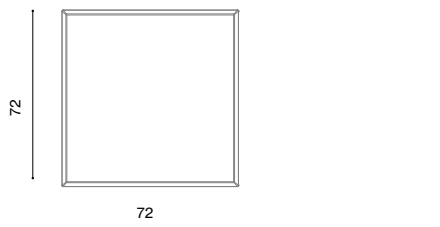

## Caratteristiche / Characteristics

Piano tavolo quadrato in alluminio verniciato per base Zebra  
Square table top in painted aluminium for Zebra base

Design / Design	Lievore Altherr   2018
Dimensioni / Dimensions	cm 72 x 72
Esterno / Outdoor	Si / yes
Struttura / Structure	Alluminio laminato / Laminated Aluminium
Elementi plastici / Plastic elements	/
Finitura / Paint finishes	Verniciatura polveri poliestere o poliuretaniche/ Paint finish with polyester or polyurethane powders
Impilabilità / Stackability	No
Viterie assemblaggio / Assembly screws	Acciaio inox con trattamento antisvitamento / Stainless steel with anti-unscrewing treatment
Peso netto singolo pezzo / Net weight	3,9 kg
Pezzi per scatola / Units per package	1 disassemblato / 1 dissembled
Dimensione e volume imballo / Packaging dimension and volume	cm 83 x 31 x 12 - 0.030 m <sup>3</sup>
Peso lordo imballo / Gross weight package	9 Kg
Garanzia / Quality guarantee	2 anni / 2 years

## Descrizione / Description

## Misure / Quotes

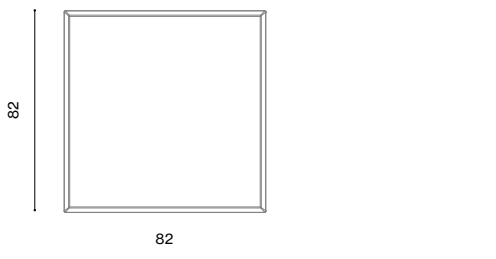
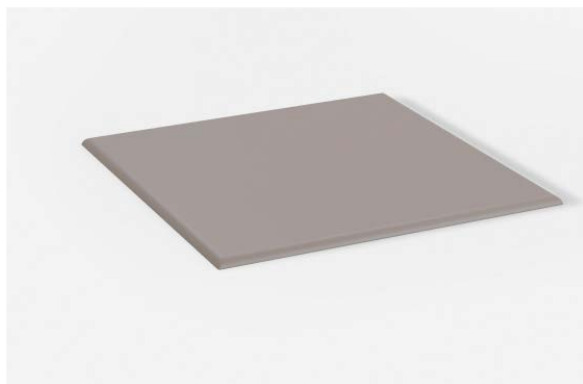

## Caratteristiche / Characteristics

Piano tavolo quadrato in alluminio verniciato perbase Zebra  
Square table top in painted aluminium for Zebra base

Design / Design	Lievore Altherr   2018
Dimensioni / Dimensions	cm W82 x 82
Esterno / Outdoor	Si / yes
Struttura / Structure	Alluminio laminato / Laminated Aluminium
Elementi plastici / Plastic elements	/
Finitura / Paint finishes	Verniciatura polveri poliestere o poliuretatiche/ Paint finish with polyester or polyurethane powders
Impilabilità / Stackability	No
Viterie assemblaggio / Assembly screws	Acciaio inox con trattamento antisvitamento / Stainless steel with anti-unscrewing treatment
Peso netto singolo pezzo / Net weight	4,8 kg
Pezzi per scatola / Units per package	1 disassemblato / 1 dissembled
Dimensione e volume imballo / Packaging dimension and volume	cm 87 x 87 x 9 - 0.068 m <sup>3</sup>
Peso lordo imballo / Gross weight package	12 Kg
Garanzia / Quality guarantee	2 anni / 2 years

## Descrizione / Description

## Misure / Quotes

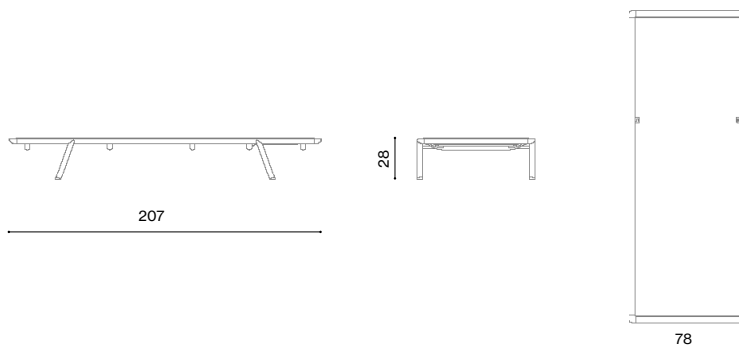

## Caratteristiche / Characteristics

Letto in alluminio verniciato e tessuto Batyline / Sunlounger in painted aluminium and Batyline fabric

Design / Design	Alberto Lievore   2023
Dimensioni / Dimensions	cm 207 x 78 x 28 h
Esterno / Outdoor	Si / yes
Struttura / Structure	Alluminio pressofuso e estruso / Die-cast, extruded and laminated aluminium
Telo / Textile	Composito PVC / PVC composite
Elementi plastici / Plastic elements	Polipropilene e polietilene / Polypropylene and polyethylene
Finitura / Paint finishes	Verniciatura polveri poliestere o poliuretatiche / Paint finish with polyester or polyurethane powders
Impilabilità / Stackability	No
Viterie assemblaggio / Assembly screws	Acciaio inox con trattamento antisvitamento / Stainless steel with anti-unscrewing treatment
Peso netto singolo pezzo / Net weight	12,8 kg
Pezzi per scatola / Units per package	1 assemblato / 1 assembled
Dimensione e volume imballo / Packaging dimension and volume	cm 220 x 94 x 46 - 0.951 m <sup>3</sup>
Peso lordo imballo / Gross weight package	33 Kg
Garanzia / Quality guarantee	2 anni / 2 years

## Accessori / Accessories



644

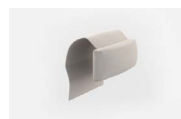

645

## Descrizione / Description

## Misure / Quotes

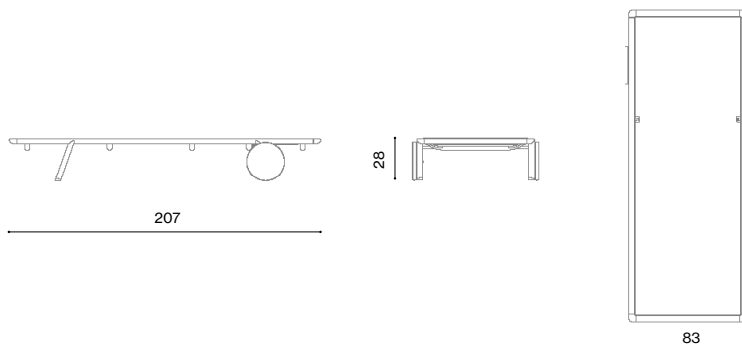

## Caratteristiche / Characteristics

Letto in alluminio verniciato e tessuto Batyline con ruote / Sunlounger in painted aluminium and Batyline fabric with castors

Design / Design	Alberto Lievore   2023
Dimensioni / Dimensions	cm 207 x 83 x 28 h
Esterno / Outdoor	Si / yes
Struttura / Structure	Alluminio pressofuso e estruso / Die-cast, extruded and laminated aluminium
Telo / Textile	Composito PVC / PVC composite
Elementi plastici / Plastic elements	Polipropilene e polietilene / Polypropylene and polyethylene
Finitura / Paint finishes	Verniciatura polveri poliestere o poliuretatiche / Paint finish with polyester or polyurethane powders
Impilabilità / Stackability	No
Viterie assemblaggio / Assembly screws	Acciaio inox con trattamento antisvitamento / Stainless steel with anti-unscrewing treatment
Peso netto singolo pezzo / Net weight	16 kg
Pezzi per scatola / Units per package	1 assemblato / 1 assembled
Dimensione e volume imballo / Packaging dimension and volume	cm 220 x 94 x 46 - 0.951 m <sup>3</sup>
Peso lordo imballo / Gross weight package	36,2 Kg
Garanzia / Quality guarantee	2 anni / 2 years

## Accessori / Accessories



644

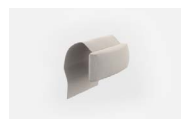

645

Numero indicativo di sedie intorno al tavolo / Indicative number of chairs around the table

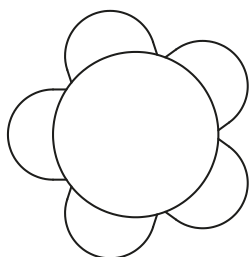

**Ø110 cm**  
5 Sedute / Seat

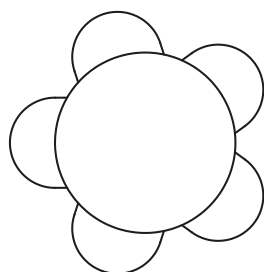

**Ø120 cm**  
5 Sedute / Seat

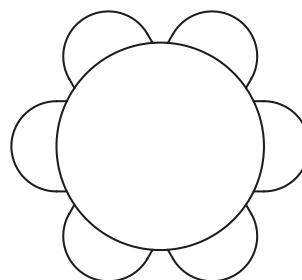

**Ø138 cm**  
6 Sedute / Seat

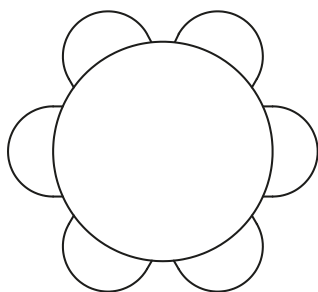

**Ø146 cm**  
6 Sedute / Seat

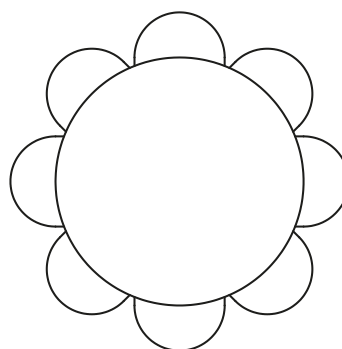

**Ø165 cm**  
8 Sedute / Seat

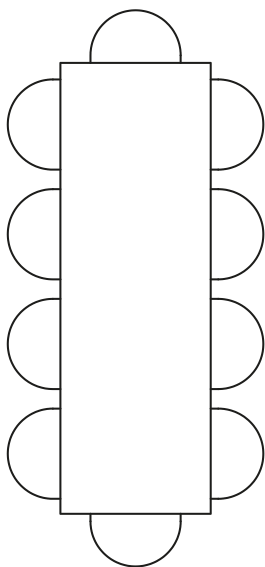

**300 x 100 cm**  
10 Sedute / Seat

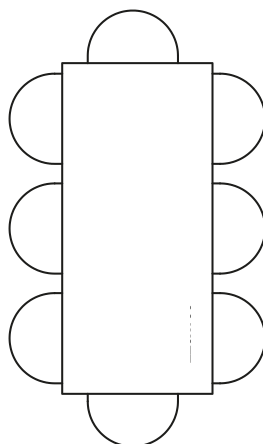

**220 x 100 cm**  
8 Sedute / Seat

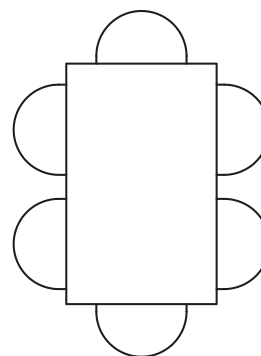

**160 x 100 cm**  
6 Sedute / Seat